

LED LIGHT BAR FRONT FOR ROOF RACK & BARS

Part Number: GRA-0A71-001150

Revised Date: 26th September 2023

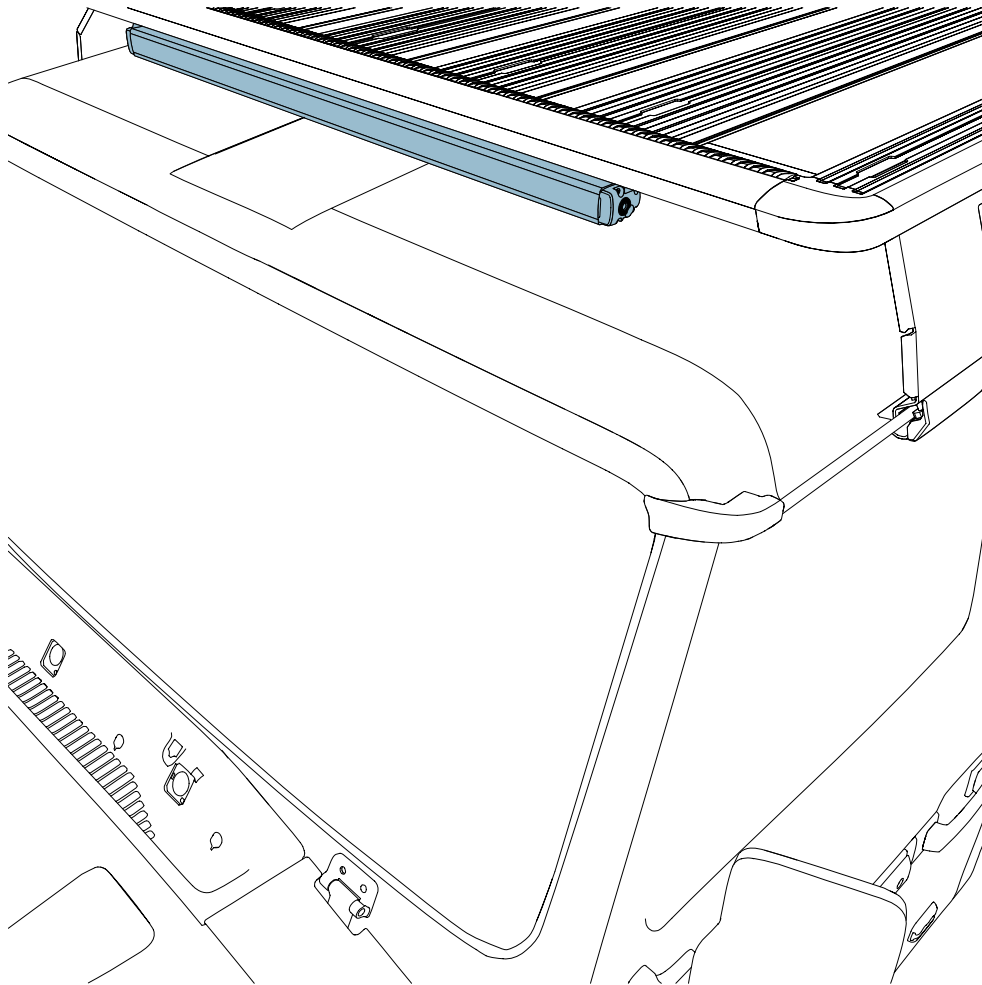

INTRODUCTION

This introduction is written for Grenadier owners and enthusiasts. It is designed to provide sufficiently detailed instructions to support those who enjoy the challenge of installing accessories to their Grenadier.

PAGE LAYOUT

Each instruction page is written in the same format:

- > The title of the fitting procedure.
- > The header table, which give technical information about the fitting procedure.
- > The parts table, which lists parts required for the task.
- > The supplies table, which lists supplies (such as oils, lubricants, adhesives) required for the task.
- > The procedure steps. Numbered and ordered, giving instructions and illustrations for each step.

WARNINGS, CAUTIONS AND NOTES

The following Warnings, Cautions and Notes are used within the repair steps:



Warning : A warning tells you that there is a risk of injury or death.



Caution : A caution tells you that there is a risk of damage to objects.



Note : A note tells you additional information that relates to the main topic.

ABBREVIATIONS

The following abbreviations are used within the Easy Repair Guide:

- > Special Service Tool (SST)
- > Manufacturer Specification Data Sheet (MSDS)

TECHNICAL QUALIFICATION

INEOS recommends that only persons who are technically competent should work on the vehicle. Work carried out by unqualified persons or using unapproved tools may result in damage to the vehicle or personal injury.

DISCLAIMER

This instruction was correct at the time of publishing. However, INEOS reserves the right to develop, improve and change any equipment, software, specifications, design, and/or information provided without notice or obligation. INEOS will not be held responsible for any inaccuracy or the consequences thereof.

©COPYRIGHT

© Copyright INEOS Automotive Limited, 2022. All Rights Reserved. These technical publications are provided for use by authorised users only. Under no circumstances should the content of any of the technical publications be reproduced, stored in a retrieval system or transmitted, in any form, electronic, mechanical, photocopying, recording or other means without prior written permission from INEOS Automotive Limited.

TABLE OF CONTENTS

Led Light Bar Front For Roof Rack & Bars (Accessory Install)	4
Parts	4
Tools	7
Procedure	7

LED LIGHT BAR FRONT FOR ROOF RACK & BARS (ACCESSORY INSTALL)

LED LIGHT BAR FRONT FOR ROOF RACK & BARS (ACCESSORY INSTALL)

Part Number	GRA-0A71-001150
Operation	Install
Model Year	Common
Body	LWB / SW & UV
Repair Time	0.3 hour

PARTS

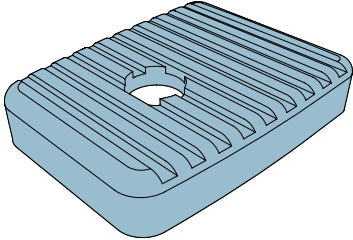
Part Number	Description	Image	Qty
GRA-0A71-001150	40" Front LED Light Bar		1
Part of Kit	Rubber Mounting Foot		2

LED LIGHT BAR FRONT FOR ROOF RACK & BARS (ACCESSORY INSTALL)

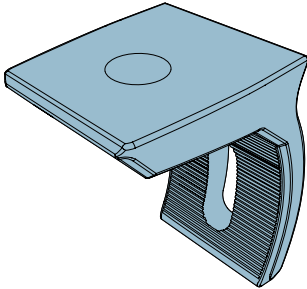
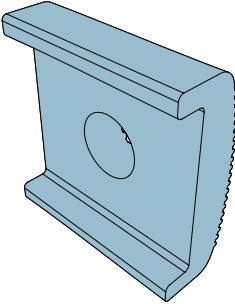
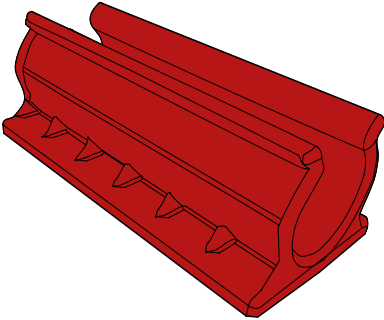
Part Number	Description	Image	Qty
Part of Kit	Mounting Bracket		2
Part of Kit	Rear Mounting Bracket		2
Part of Kit	Cable Gutter Clips		6

LED LIGHT BAR FRONT FOR ROOF RACK & BARS (ACCESSORY INSTALL)

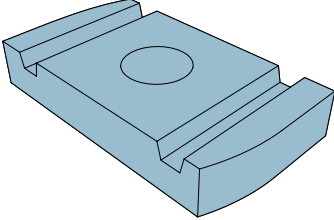
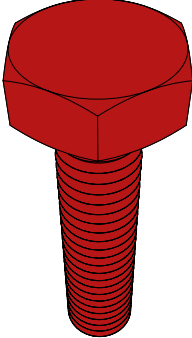
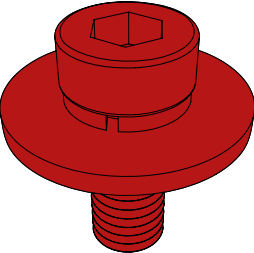
Part Number	Description	Image	Qty
Part of Kit	Channel Nuts		4
Part of Kit	Bolt		2
Part of Kit	Cable Support bolt		2

LED LIGHT BAR FRONT FOR ROOF RACK & BARS (ACCESSORY INSTALL)

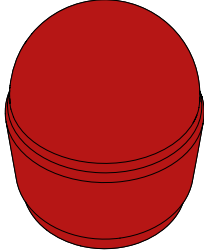
Part Number	Description	Image	Qty
Part of Kit	Dome Nut		2

TOOLS

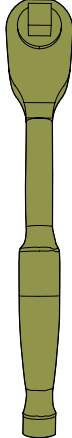
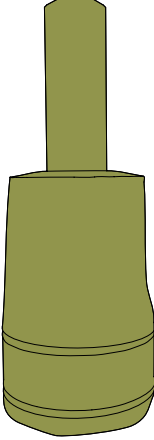
Part Number	Description	Image	Qty
Local Supply	3/8 Ratchet		1
Local Supply	3/8 Hex Key		1

PROCEDURE

Install

LED LIGHT BAR FRONT FOR ROOF RACK & BARS (ACCESSORY INSTALL)

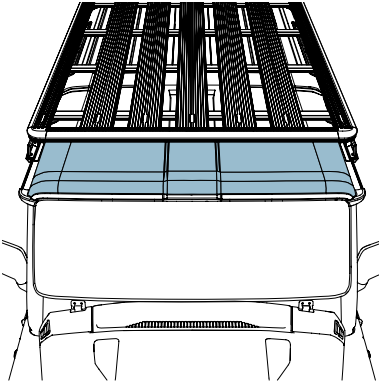
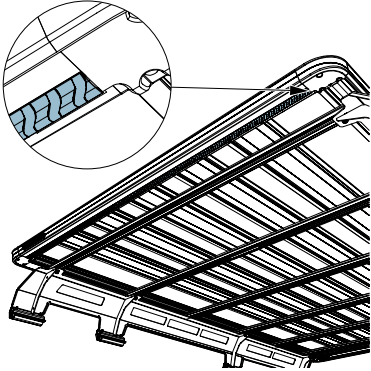
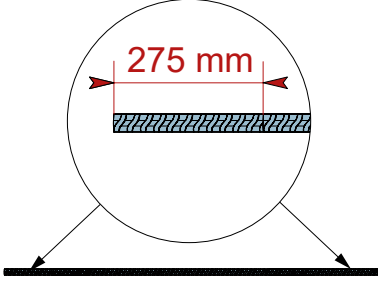
1	<p> Caution: Do not let petrol touch the LED Light Bar. Petrol can damage the LED Light Bar Front-Cover. This will prevent correct operation of the LED Light Bar.</p> <p>Apply the applicable protection to the Roof.</p> 
2	<p>Remove the Strip.</p> 
3	<p>Measure 275 mm from the two ends of the Strip.</p> 
4	<p>Mark the Strip at 275 mm from the two ends of the Strip.</p>
5	<p>Cut the Strip along the two marks you made in step 4.</p>
6	<p>Put the two end-segments of the Strip aside.</p>

LED LIGHT BAR FRONT FOR ROOF RACK & BARS (ACCESSORY INSTALL)

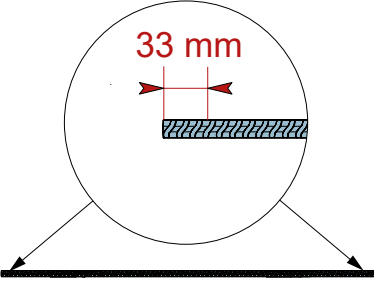
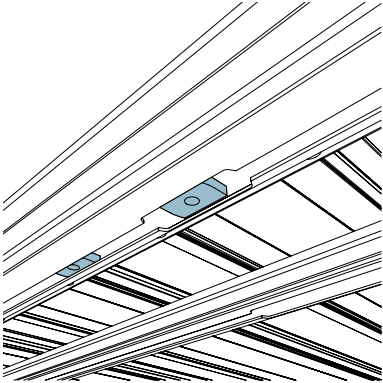
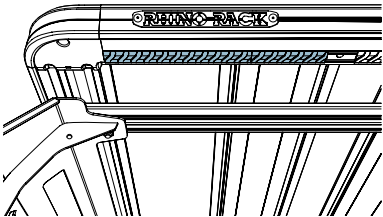
7	<p>Measure 33 mm from the two ends of the Strip Centre-Segment.</p>  <p>The diagram shows a circular callout of a rectangular strip with a hatched pattern. A red double-headed arrow above the strip indicates a measurement of 33 mm from each end. Two arrows point from the corners of the circle down to the corners of the main rectangular strip below it.</p>
8	<p>Mark the Strip Centre-Segment at 33 mm from the two ends of the Strip Centre-Segment.</p>
9	<p>Cut the Strip Centre-Segment along the two marks you made in step 8.</p>
10	<p>Discard the two offcuts from the Strip Centre-Segment.</p>
11	<p>Put the Strip Centre-Segment aside.</p>
12	<p>Install the two Channel Nuts to the Roof Rack.</p>  <p>The diagram shows a perspective view of a roof rack bar with two blue channel nuts being slid onto it. The nuts have a circular hole on their top surface.</p>
13	<p>Install the right Strip Segment to the Roof Rack.</p>  <p>The diagram shows a close-up of a hatched LED strip segment being inserted into a blue channel nut that is already mounted on a roof rack bar. The bar has the text '© RIVNO RACKS' visible on it.</p>

LED LIGHT BAR FRONT FOR ROOF RACK & BARS (ACCESSORY INSTALL)

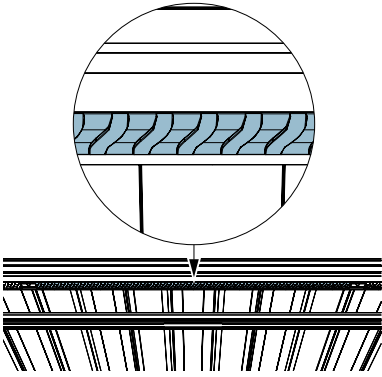
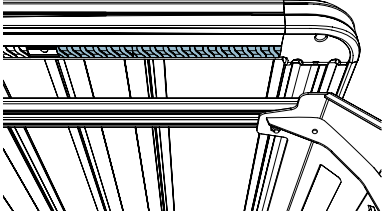
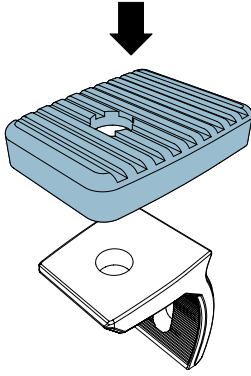
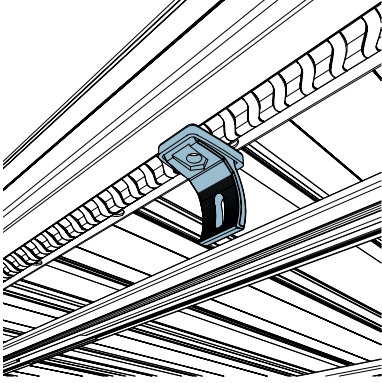
14	<p>Install the centre Strip Segment to the Roof Rack.</p> 
15	<p>Install the left Strip Segment to the Roof Rack.</p> 
16	<p>Install the two Rubber Mounting Feet to the two Mounting Brackets.</p> 
17	<p>Move the Mounting Bracket into position.</p> 

LED LIGHT BAR FRONT FOR ROOF RACK & BARS (ACCESSORY INSTALL)

18  *Note: Make sure that the Mounting Bracket and Channel Nuts are correctly aligned in the Roof Rack Channel.*

Install and torque the bolt that attaches the Mounting Bracket to the Roof Rack to **9 Nm**

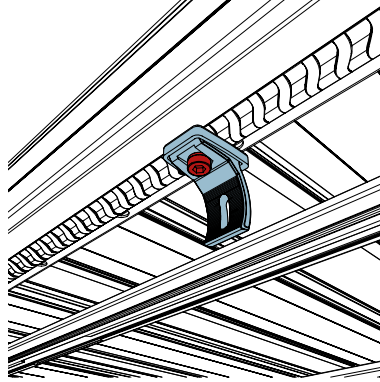

19 Move the Mounting Bracket into position.

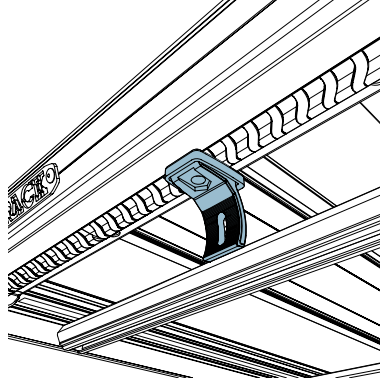

20  *Note: Make sure that the Mounting Bracket and Channel Nuts are correctly aligned in the Roof Rack Channel.*

Install and torque the bolt that attaches the Mounting Bracket to the Roof Rack to **9 Nm**

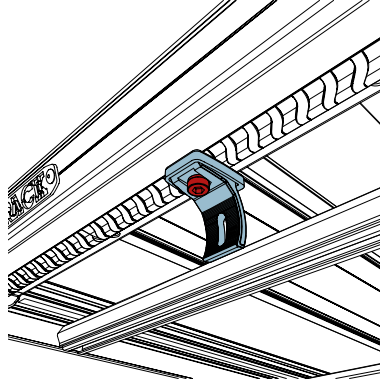

21 Install the two bolts to the Light Bar.

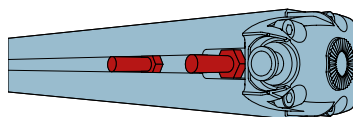

LED LIGHT BAR FRONT FOR ROOF RACK & BARS (ACCESSORY INSTALL)

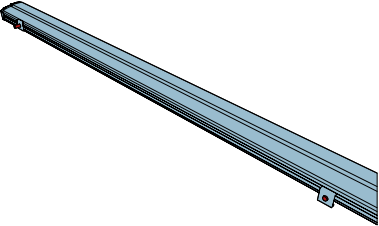
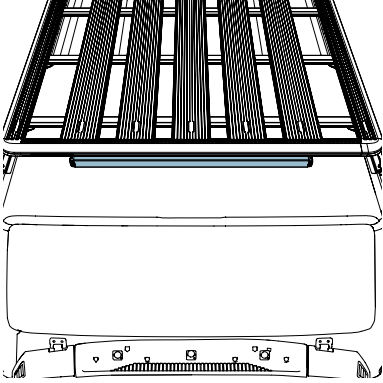
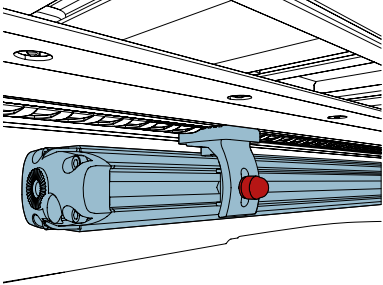
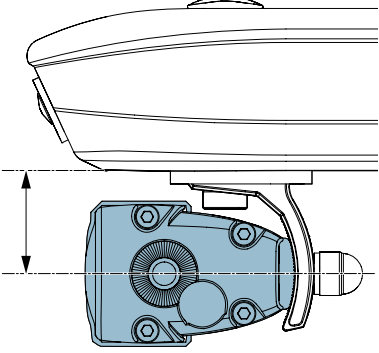
22	<p>Install the two Rear Mounting Brackets to the two Light Bar Bolts.</p> 
23	<p>Move the Light Bar Assembly into position.</p> 
24	<p>Install the two Dome Nuts that attach the Light Bar to the Mounting Brackets.</p> 
25	<p>Make sure that the Light Bar points forward, parallel to the Roof Rack.</p> 

LED LIGHT BAR FRONT FOR ROOF RACK & BARS (ACCESSORY INSTALL)

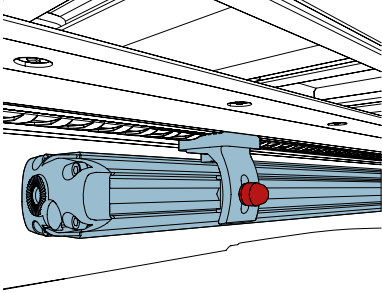
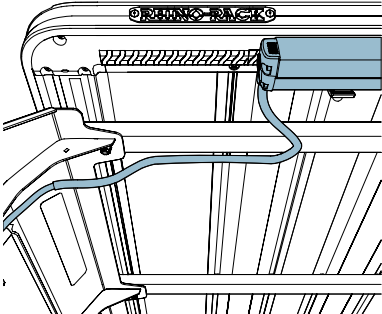
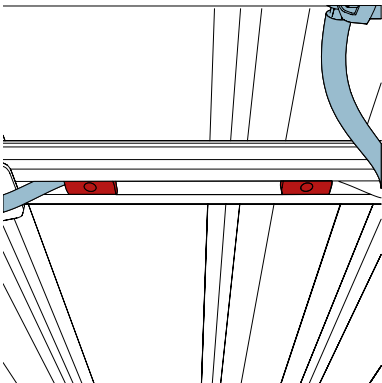
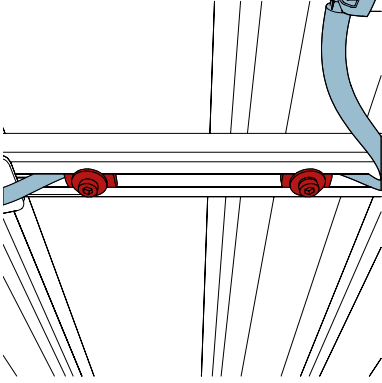
26	<p>Torque the two Dome Nuts that attach the Light Bar to the Mounting Brackets to 8 Nm</p>  <p>The diagram shows a perspective view of a light bar being attached to a mounting bracket. A red dome nut is shown being inserted into the bracket to secure the light bar. The light bar is blue and has a lens at the front.</p>
27	<p>Route the Light Bar Harness through the Roof Rack Channel.</p>  <p>The diagram shows a top-down view of a roof rack. A blue harness is being routed through a channel in the roof rack. The roof rack is labeled 'RHINO RACK'.</p>
28	<p>Install the two Channel Nuts to the Roof Rack.</p>  <p>The diagram shows a side view of a roof rack channel. Two red channel nuts are being inserted into the channel. A blue harness is also visible, routed through the channel.</p>
29	<p>Install and torque the two bolts that attach the Channel Nuts to the Roof Rack to 9 Nm</p>  <p>The diagram shows a side view of a roof rack channel. Two red channel nuts are now secured to the channel with two red bolts. A blue harness is also visible, routed through the channel.</p>

LED LIGHT BAR FRONT FOR ROOF RACK & BARS (ACCESSORY INSTALL)

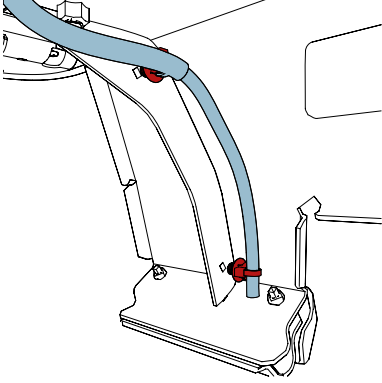
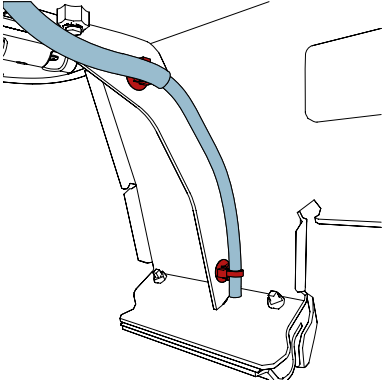
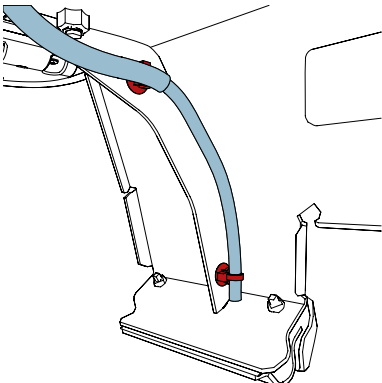
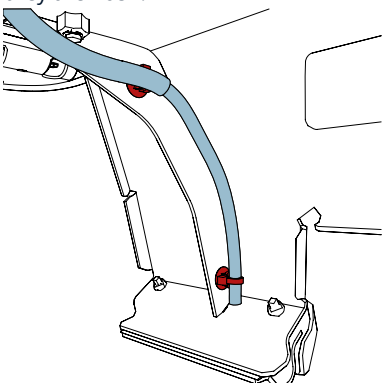
30	<p>Loosely install the two Cable Tie Clips to the Light Bar Harness.</p>  <p>The diagram shows a light bar harness (blue) being attached to a roof rack. Two red cable tie clips are being inserted into the harness. The harness is shown in a perspective view, and a side view of the roof rack is shown to the right.</p>
31	<p>Install the two Cable Tie Clips to the Roof Rack.</p>  <p>The diagram shows the two red cable tie clips being inserted into the roof rack. The harness is shown in a perspective view, and a side view of the roof rack is shown to the right.</p>
32	<p>Tighten the two Cable Tie Clips.</p>  <p>The diagram shows the two red cable tie clips being tightened. The harness is shown in a perspective view, and a side view of the roof rack is shown to the right.</p>
33	<p>Cut the two Cable Tie Ends so that they are flush.</p>  <p>The diagram shows the two red cable tie clips being cut so that they are flush. The harness is shown in a perspective view, and a side view of the roof rack is shown to the right.</p>

LED LIGHT BAR FRONT FOR ROOF RACK & BARS (ACCESSORY INSTALL)

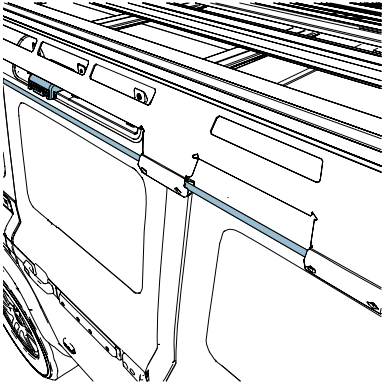
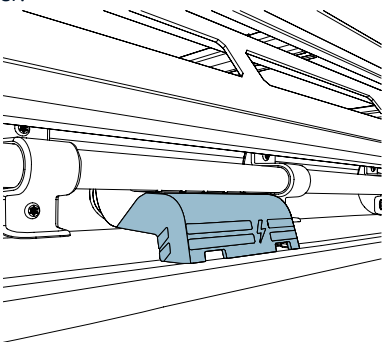
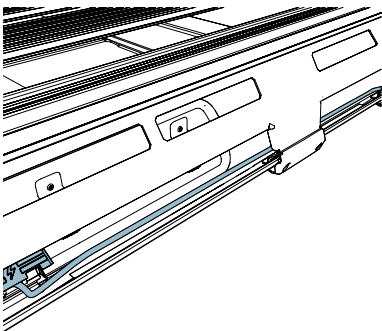
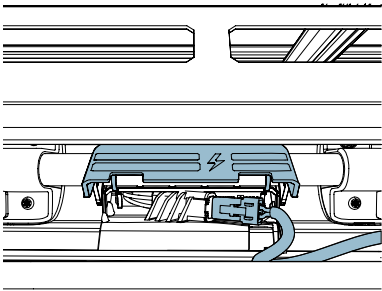
34	Clean the Drain Gutter. 
35	Open the Light Bar Connector Cover. 
36	Route the Light Bar Harness under the Roof Rack. 
37	Connect the Electrical Connector to the Rooflight Adapter Harness. 

LED LIGHT BAR FRONT FOR ROOF RACK & BARS (ACCESSORY INSTALL)

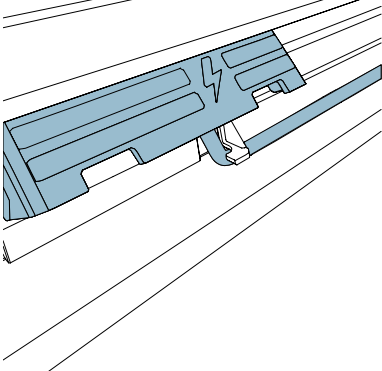
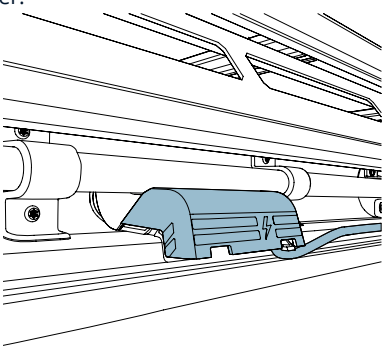
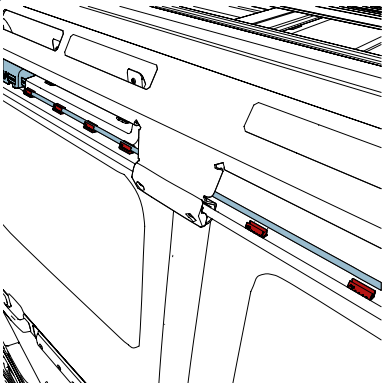
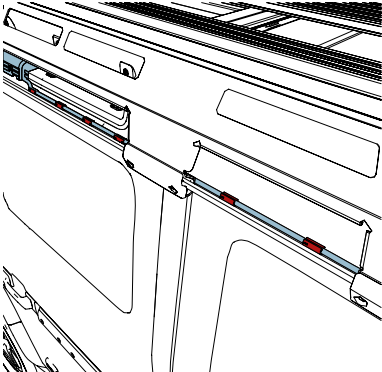
38	<p>Route the Light Bar Harness through the Roof Connector Base.</p>  A technical line drawing showing a blue light bar harness being inserted into a blue roof connector base. The harness is shown as a bundle of wires with a lightning bolt symbol on its side, indicating it is an electrical component. The base is a rectangular component with a slot for the harness to pass through.
39	<p>Close the Light Bar Connector Cover.</p>  A technical line drawing showing the light bar connector cover being closed. The cover is a blue, curved component that fits over the roof connector base. It is shown in the process of being snapped onto the base, with the harness wires visible through the cover's opening.
40	<p>Install the six Cable Clips to the Light Bar Harness.</p>  A technical line drawing showing six cable clips being installed onto the light bar harness. The clips are small, red and blue components that are being attached to the harness wires. The harness is shown as a bundle of wires with a lightning bolt symbol on its side.
41	<p>Remove the Protective Layer from the Cable Clip.</p>
42	<p>Install the Cable Clip to the Roof Gutter.</p>  A technical line drawing showing a cable clip being installed to the roof gutter. The clip is shown being inserted into a slot in the roof gutter. The harness wires are shown passing through the clip and into the gutter.
43	<p>Repeat steps 41 and 42 five more times for the remaining Cable Clips.</p>

LED LIGHT BAR FRONT FOR ROOF RACK & BARS (ACCESSORY INSTALL)

44

Remove the protection from the Roof.

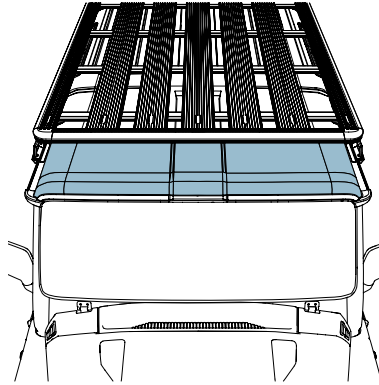

INEOS

GRENA^ADIER