

# M1 CARGO BARRIER

Part Number: GRA-0A41-001030

Revised Date: 28th September 2023

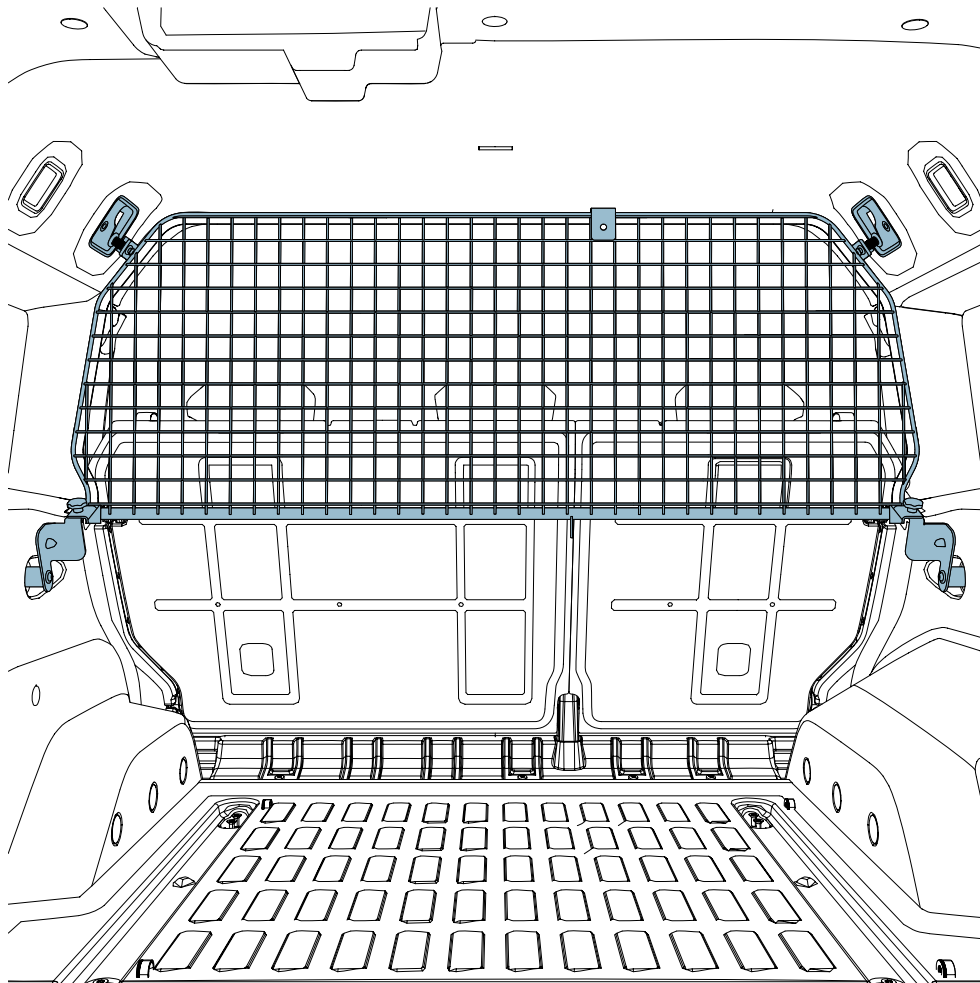

## INTRODUCTION

This introduction is written for Grenadier owners and enthusiasts. It is designed to provide sufficiently detailed instructions to support those who enjoy the challenge of installing accessories to their Grenadier.

## PAGE LAYOUT

Each instruction page is written in the same format:

- > The title of the fitting procedure.
- > The header table, which give technical information about the fitting procedure.
- > The parts table, which lists parts required for the task.
- > The supplies table, which lists supplies (such as oils, lubricants, adhesives) required for the task.
- > The procedure steps. Numbered and ordered, giving instructions and illustrations for each step.

## WARNINGS, CAUTIONS AND NOTES

The following Warnings, Cautions and Notes are used within the repair steps:



**Warning :** A warning tells you that there is a risk of injury or death.



**Caution :** A caution tells you that there is a risk of damage to objects.



**Note :** A note tells you additional information that relates to the main topic.

## ABBREVIATIONS

The following abbreviations are used within the Easy Repair Guide:

- > Special Service Tool (SST)
- > Manufacturer Specification Data Sheet (MSDS)

## TECHNICAL QUALIFICATION

INEOS recommends that only persons who are technically competent should work on the vehicle. Work carried out by unqualified persons or using unapproved tools may result in damage to the vehicle or personal injury.

## DISCLAIMER

This instruction was correct at the time of publishing. However, INEOS reserves the right to develop, improve and change any equipment, software, specifications, design, and/or information provided without notice or obligation. INEOS will not be held responsible for any inaccuracy or the consequences thereof.

## ©COPYRIGHT

© Copyright INEOS Automotive Limited, 2022. All Rights Reserved. These technical publications are provided for use by authorised users only. Under no circumstances should the content of any of the technical publications be reproduced, stored in a retrieval system or transmitted, in any form, electronic, mechanical, photocopying, recording or other means without prior written permission from INEOS Automotive Limited.

# TABLE OF CONTENTS

---

Cargo Barrier (Accessory Install) .....	4
Parts .....	4
Tools .....	6
Procedure .....	6

## M1 CARGO BARRIER (INSTALL)

### CARGO BARRIER (ACCESSORY INSTALL)

<b>Part Number</b>	GRA-0A41-001030
<b>Operation</b>	Install
<b>Model Year</b>	Common
<b>Body</b>	LWB / SW & UV
<b>Repair Time</b>	0.1 hour

### PARTS

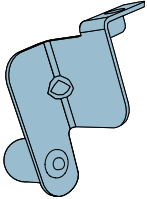
Part Number	Description	Image	Qty
GRA-0A41-001030	Utility Cargo Barrier - Half-Height		1
Part of Kit	Lower Bracket LH		1

## M1 CARGO BARRIER (INSTALL)

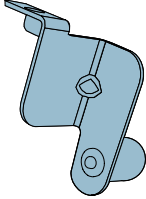
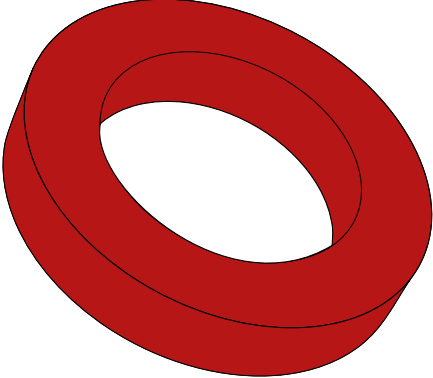
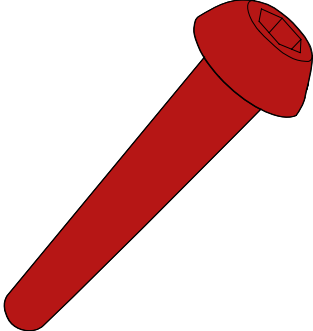
Part Number	Description	Image	Qty
Part of Kit	Lower Bracket RH	 A blue metal bracket with a curved shape, a hole, and a mounting point.	1
Part of Kit	Washer	 A red circular washer with a central hole.	2
Part of Kit	Bolt M8x55	 A red bolt with a hexagonal head and a threaded shaft.	2

## M1 CARGO BARRIER (INSTALL)

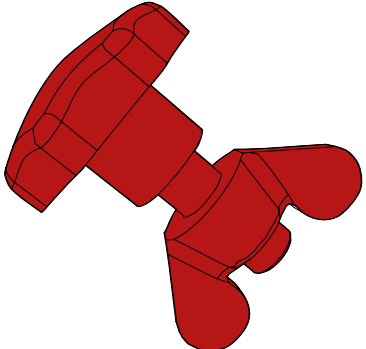
Part Number	Description	Image	Qty
Part of Kit	Thumb Screw		2

### TOOLS

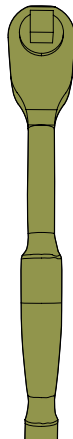
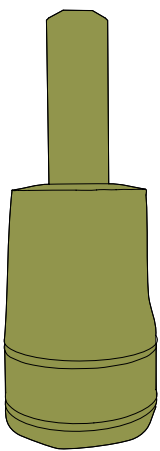
Part Number	Description	Image	Qty
Local Supply	3/8 Ratchet		1
Local Supply	Hex Key		1

### PROCEDURE

*Installation Location: Load Area*

Install

## M1 CARGO BARRIER (INSTALL)

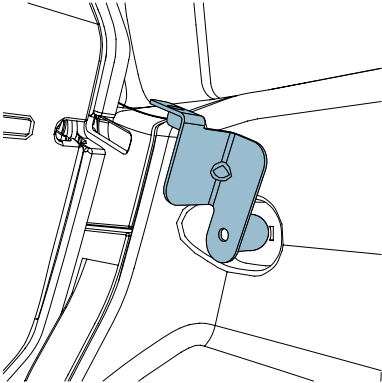
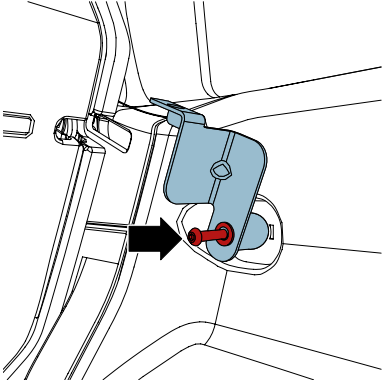
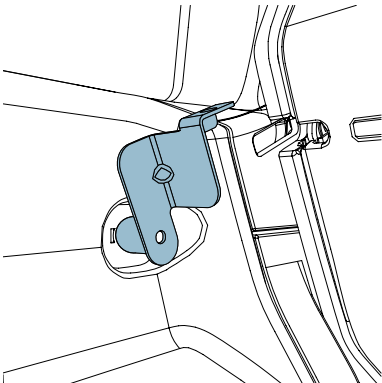
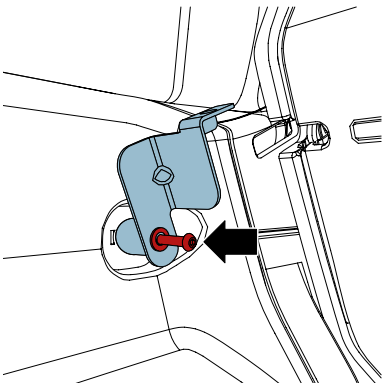
1	<p>Move the Bracket into position.</p> 
2	<p>Loosely install the bolt and washer that attaches the Bracket to the Load Space Trim.</p> 
3	<p>Move the Bracket into position.</p> 
4	<p>Loosely install the bolt and washer that attaches the Bracket to the Load Space Trim.</p> 

## M1 CARGO BARRIER (INSTALL)

5

Move the Cargo Barrier into position.

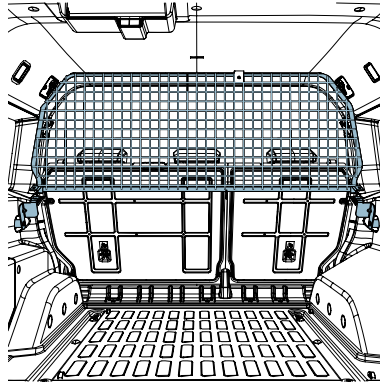

6

Install the Cargo Barrier to the two Partition Hooks.

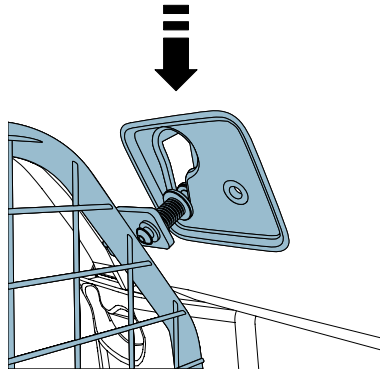

7

Install and tighten the two Thumb Screw and Wing Nut Assemblies.

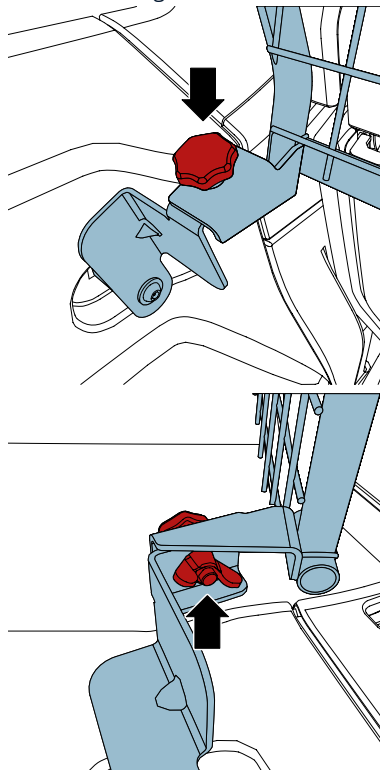



## M1 CARGO BARRIER (INSTALL)

---

8

Torque the two bolts that attach the Brackets to the Load Space Trims to **27 Nm**

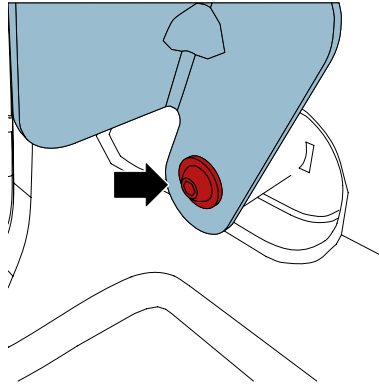

**INEOS**  

---

**GRENA<sup>A</sup>DIER**