

INEOS

GRENADIER

OWNER'S MANUAL

Welcome to your Grenadier

You're now not only the owner of a 4x4 with a story like no other. You're one of a group of like-minded individuals playing your part in the Grenadier's journey.

What began in 2016 as founder Jim Ratcliffe's vision to create a truly robust, reliable and ready-to-work 4x4 is now a reality. Fulfilling that idea and building the vehicle you're driving today has been a huge team effort, with our people, our partners and now drivers like yourself rising to every challenge.

This guide is intended to help you familiarise yourself with, and get the most from, your Grenadier. But there's nothing as instructive as getting out there and driving it. That's where your Grenadier's build quality and off-road capabilities will speak for themselves.

In short, shiny and new as it is, there's no need to treat your Grenadier delicately. It was conceived, designed and built on purpose. It's time to put it to yours.



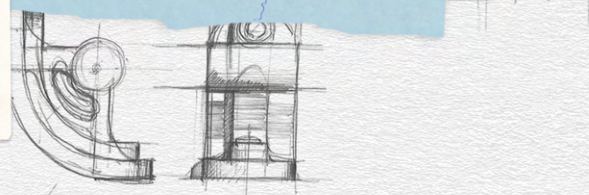
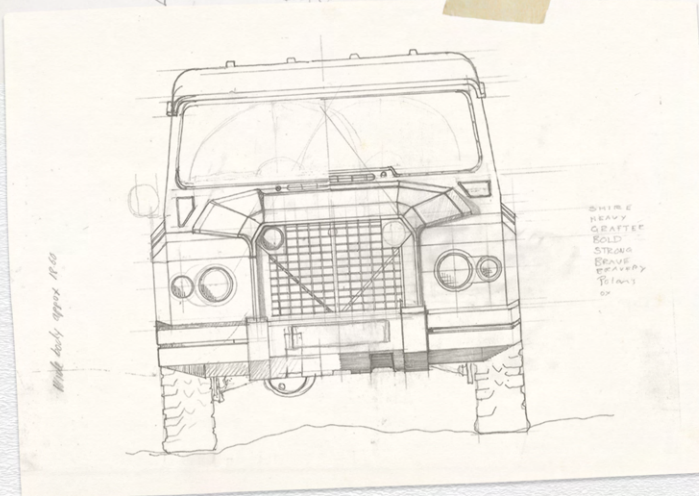
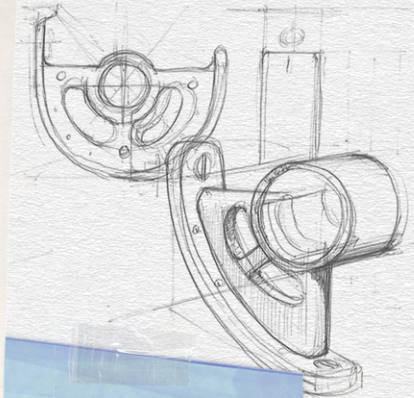
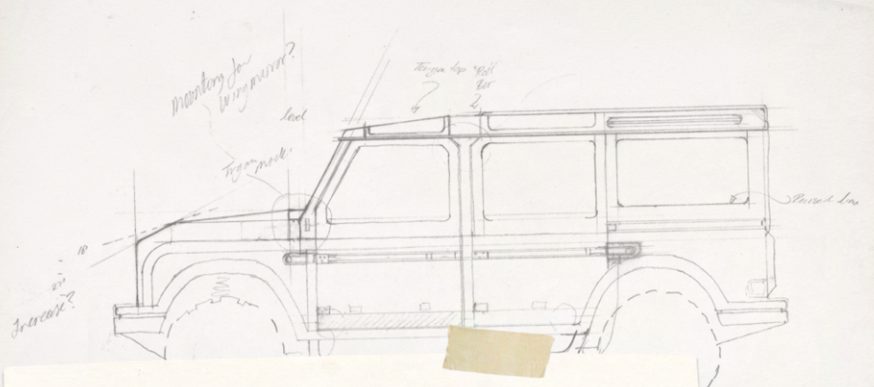

"It's not a very complicated vehicle - the boxy design is a result of a wheel in each corner, a ladder frame, then an engine of a certain size, which needs a certain number of radiators and cooling and space for crashing."

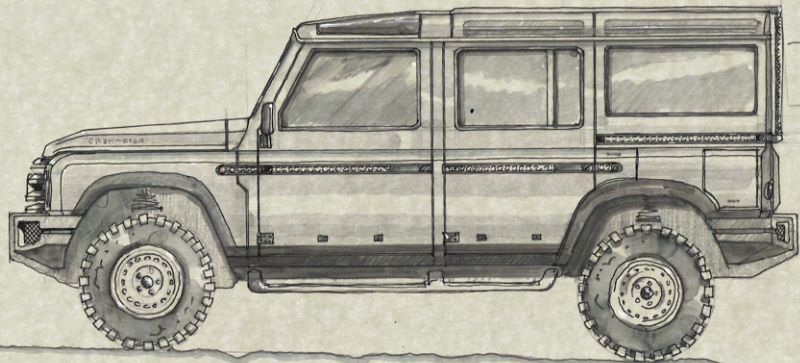

"We like the idea that it grows with you
- it's made of beautiful saddle leathers,
that will mature with time and gain
a patina. It becomes very personal to the
people that are driving it all the time.
It's a living element of the vehicle."

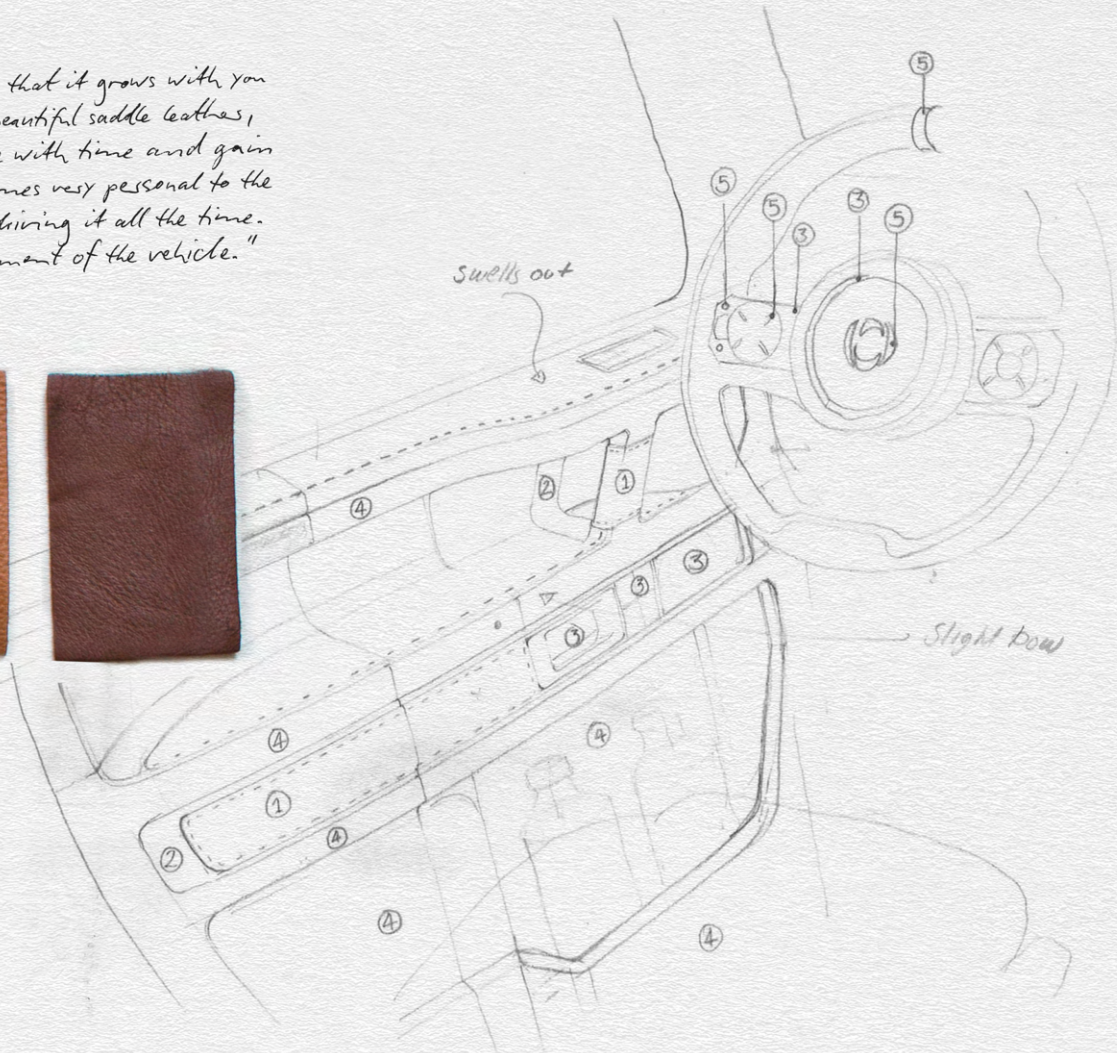

"A round headlight at the front
and a round rear light is this
nice idea of something that just
continues through the vehicle."

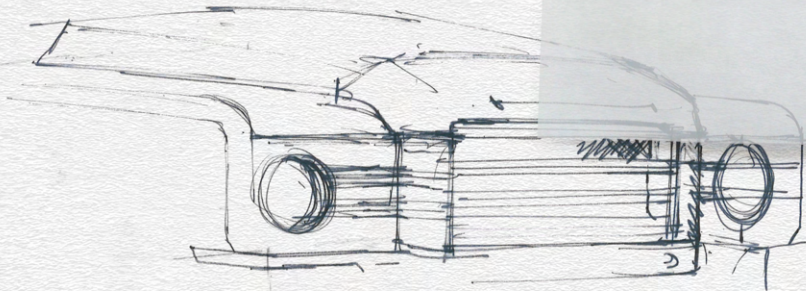
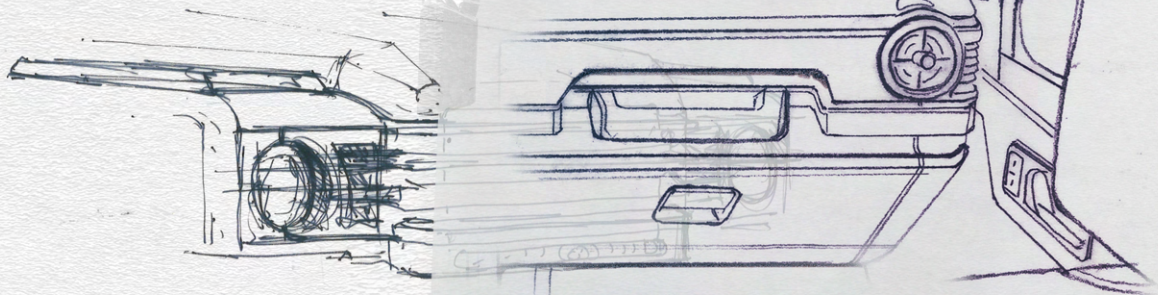

"Having the central stack means that everyone can be engaged in the whole process of driving and on the journey."

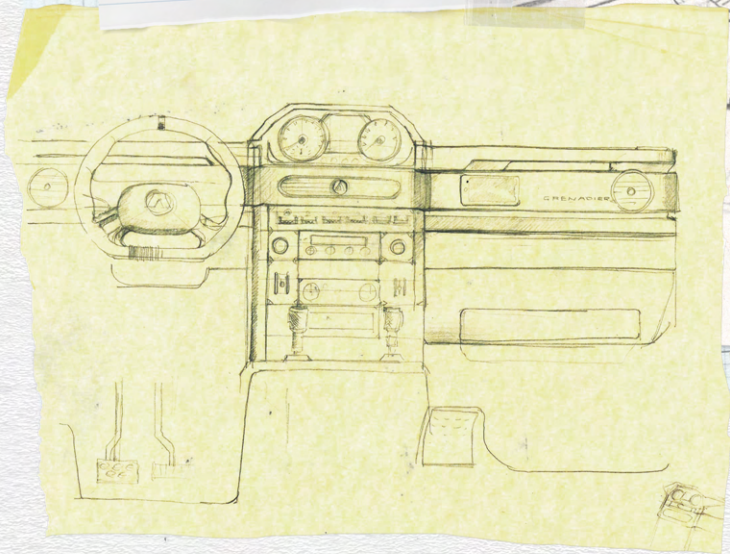
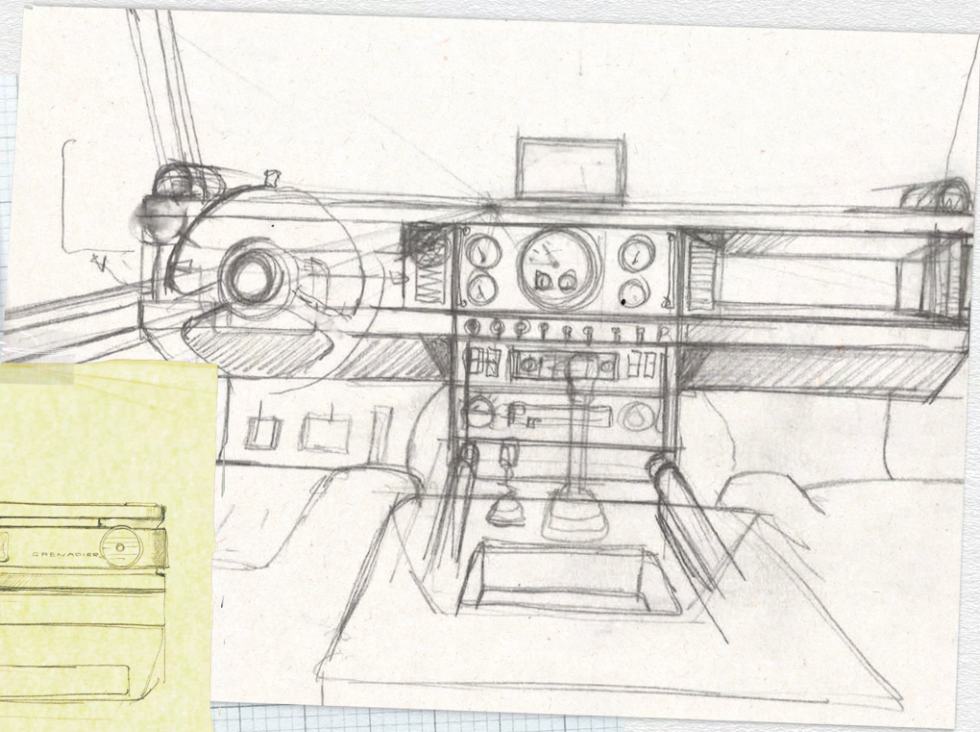

"We didn't set out to make it look like anything else - it was always engineering-led. Function always wins."

Copyright

This publication was correct at the time of going to print. However, we reserve the right to develop, improve and change any equipment, specifications, design and/or information provided without notice or obligation. The manufacturer and agent/dealer will not be held responsible for any inaccuracy or the consequences thereof.

Any software instructions printed inside the book were correct and up to date at the time of printing. However, software can be updated over time with continued improvements over the lifetime of the vehicle. Contact your INEOS representative for further information.

© Copyright INEOS Automotive Limited, 2022. All Rights Reserved. This publication is provided with your vehicle for your personal, private, and non-commercial use. Under no circumstances should the content in this Owner's Manual be reproduced, stored in a retrieval system, or transmitted, in any form, electronic, mechanical, photocopying, recording or other means without prior written permission from INEOS Automotive Limited.

INEOS

GRE^ADIER

TABLE OF CONTENTS

INTRODUCTION	14
QUICK START	19
BEFORE DRIVING	33
VEHICLE OPERATION	58
DRIVER SUPPORT AND FEATURES	100
VEHICLE SECURITY	126
MEDIA AND INFOTAINMENT	129
CLIMATE CONTROL	164
MAINTENANCE AND TECHNICAL INFORMATION	167
WARRANTY INFORMATION	216

INTRODUCTION

ABOUT THIS MANUAL	15
VEHICLE IDENTIFICATION AND ENGINE NUMBER	15
DATA RECORDING	17
DRIVING SAFETY	18

INTRODUCTION

ABOUT THIS MANUAL

Thank you for choosing your INEOS Grenadier.

This Owner's Manual has been designed to explain the vehicle's operation and to make the control of its systems easy to understand and operate. The more familiar you are with your vehicle, the better control you will have on and off the road. We therefore strongly suggest reading the Owner's Manual before driving.

The Owner's Manual has been printed with information to help keep the vehicle well maintained, reliable and safe. Which will contribute to maintaining the value of your INEOS Grenadier.

The information in this manual is created for all variants of the vehicle. Thus, it is possible that some of the information will not be applicable for your vehicle variant.

You must always comply with the specific laws and regulations of the country that you are in. These laws may differ from the information in this Owner's Manual. This Owner's Manual forms part of the essential vehicle equipment for homologation purposes and must stay with the vehicle at all times.

The advice given in this Owner's Manual is for guidance only and is not intended to be an exhaustive list of appropriate actions in all circumstances. If in doubt, owners should consult an INEOS approved Partner.

Warnings, Cautions and Notes

The following Warnings, Cautions and Notes are used within this Owner's Manual:



WARNING: A warning tells you that there is a risk of injury or death.



CAUTION: A caution tells you that there is a risk of damage to objects.



NOTE: A note tells you additional information that relates to the main topic.

Component Location

Component location and positioning will be described as viewed from the centre of the vehicle looking forward.

VEHICLE IDENTIFICATION AND ENGINE NUMBER

The Vehicle Identification Number (VIN) consists of seventeen characters.

The VIN can be found in the following locations:

- > Windscreen - Bottom of the windscreen, in the corner.
- > Door Shut - Driver side door shut panel on the manufacturer's label.
- > Chassis Rail - Right side chassis rail (front section of the wheel house).

INTRODUCTION

Chassis Rail VIN location:

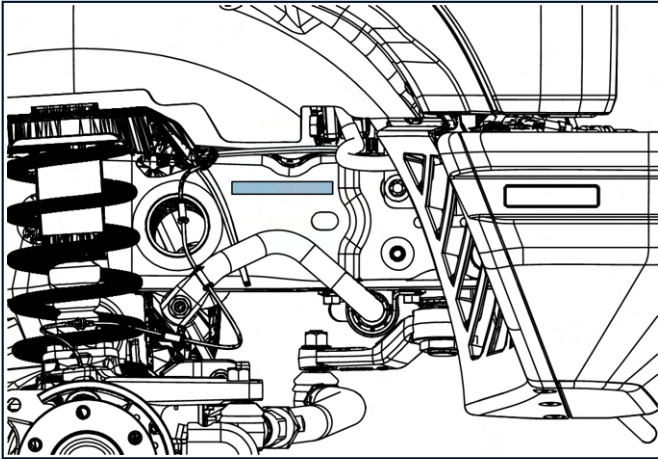

The engine number consists of two separate codes. The first code is the engine number and the second code is the engine identification number or the designation number.

The B57 Diesel engine number, can be found on the engine casing as seen in the following example image:

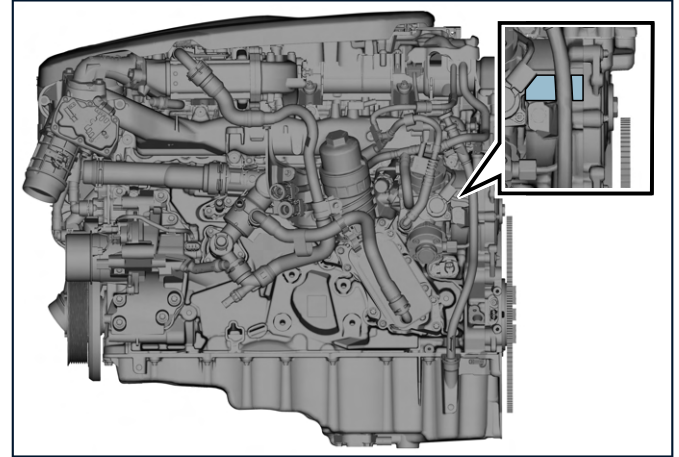

INTRODUCTION

The B58 Petrol engine number, can be found on the engine casing as seen in the following example image:

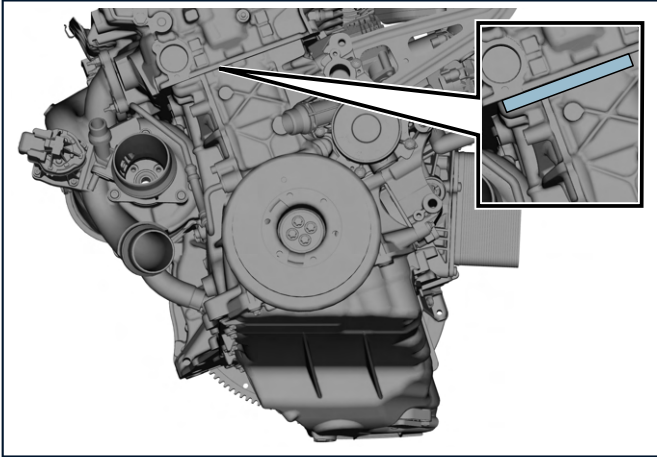

DATA RECORDING

There are various electronic modules and components in this vehicle with the ability to record detailed data temporarily and permanently. The information and data recorded, can be conditions of the vehicle, such as, faults or the condition of some

mechanical parts or safety systems. Other examples of recorded data might be the following:

- > Operating conditions of system.
- > Components such as fill levels for fluids.
- > The use of restraint systems or the conditions of the airbag system.
- > Information about the performance of various systems and modules.
- > Environmental conditions such as temperature.
- > Information relating to the operation of the vehicle at the time of a near collision, or in the event of a crash, such as, the vehicle speed or brake application.



NOTE: Information may be stored during regular road and off-road use.

The information stored temporarily or permanently, by the vehicle systems can be read and used by authorities, such as, law enforcement or government agencies (if required), with special equipment and access to the vehicle. This may occur if the vehicle has been involved in any event, such as, a near miss collision or a crash. Service and repair facilities may require the use of the data stored within the vehicle systems to understand where and why, there may have been a malfunction or error. This is critical in providing precise and effective diagnostics to the vehicle, to ensure the occupants are safe when the vehicle is in use, both on road and off-road.

INTRODUCTION



NOTE: The data and information stored in the vehicle, might also be required by others who may assert a right or obtain your consent to know such information.

DRIVING SAFETY



NOTE: It is important to wear suitable footwear when operating the vehicle to efficiently operate the control pedals. Make sure the area around the pedals is clear and that there will be no obstructions when operating the pedals. This includes checking the floor mats (if applicable) are situated in the correct position.

- > All occupants should wear the fitted seat belts, when the vehicle is being driven.
- > Never drive under the influence of alcohol or drugs.
- > When driving for long periods of time, take regular breaks.
- > Do not drive when you are tired.
- > Do not use any handheld devices when driving the vehicle.
- > Before driving, be sure to have a clear view through the windscreen and all mirrors including the rear view mirror.

- > All regulations and traffic laws must be obeyed for the safety of all occupants and others around you.
- > Never exceed the legal speed limit in your country.
- > Familiarise yourself with the vehicle and always drive aware of both your own and the vehicles limitations. Failure to operate the vehicle correctly can result in accident and injury.
- > When driving off-road or in extreme conditions, be sure to have suitable supplies and safety equipment in the vehicle with you.
- > Follow the maintenance schedule approved in this guide.
- > Never allow the vehicle to be driven by unqualified drivers.
- > The usage of seat belt dummies is forbidden.
- > As the driver, you are responsible for the occupants in your vehicle. Be sure the occupants also follow applicable safety advice, regulations and traffic laws.

QUICK START

CHECKS BEFORE DRIVING	20
VEHICLE KEY	20
ADJUSTING THE STEERING WHEEL	21
CENTRE CONSOLE	22
STEERING WHEEL CONTROLS	24
HAZARD LAMPS	26
TELL-TALE LAMPS	26
CONNECTING PHONE DEVICE	30
CONNECTING APPLE CARPLAY	31
CONNECTING ANDROID AUTO	32

QUICK START

CHECKS BEFORE DRIVING

Inspect your vehicle before driving it. This may include, but is not limited to the following:

- > Visually check the road wheels, wheel nuts and tyres.
- > Check that all the windows, mirrors, and lamps are clear and unobstructed.
- > Check the operation of all lamps.
- > Check that the doors are securely closed.
- > Check that the seat, mirrors, and steering wheel adjustments are correct.
- > Check that all gauges and symbols are reading correctly.
- > Check that all passengers have fastened their seat belts.

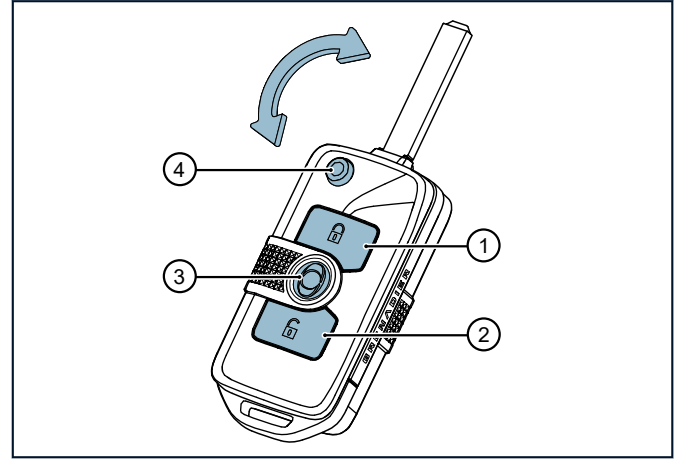

VEHICLE KEY



WARNING: Care should be taken that the vehicle key is not left in the vehicle with only occupants, such as, young children or pets inside.

NUMBER	BUTTON	FUNCTION
1	Lock	Press and release to lock the vehicle and arm the security system.

QUICK START

NUMBER	BUTTON	FUNCTION
2	Unlock	Press and release to unlock the drivers door.
3	Panic	The panic button will set off the alarm of the vehicle.
4	Key Blade	Press the button to release the key blade, to manually unlock and lock the vehicle.

When the vehicle is locked using the key, the headlamps will illuminate for a short period of time to illuminate the space ahead.



NOTE: If the vehicle key is lost, contact your INEOS partner.

To adjust the steering wheel up and down, pull down on the lever beside the steering wheel, moving the steering wheel up or down until positioned comfortably. Holding the steering wheel in position, pull the lever upwards to lock in place.

ADJUSTING THE STEERING WHEEL



WARNING: Do not adjust the steering wheel, when the vehicle is in motion. Only adjust the steering wheel position when the vehicle is parked and it is safe to do so. Adjusting the steering wheel when the vehicle is moving may result in a crash.

Adjust the steering wheel height, for a comfortable driving position.

QUICK START

CENTRE CONSOLE

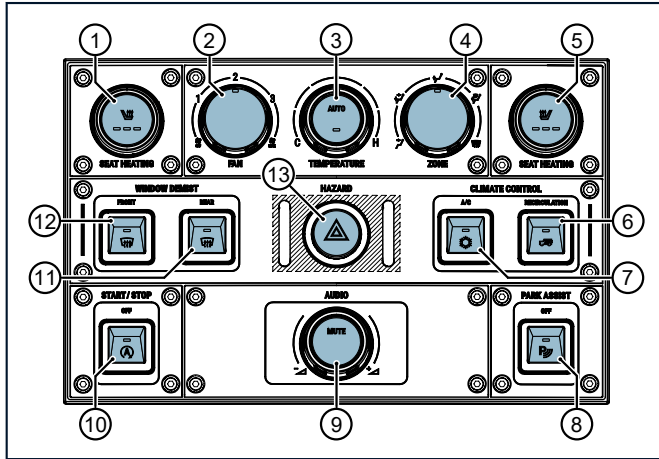

NUMBER	BUTTON	DEFINITION
1	Heated Front Seat (OPTIONAL)	Independently controlled heated front seats with three temperature settings for both the driver and passenger.
2	Fan Speed Setting	Setting to increase or decrease the speed of the fan.
3	Temperature and Auto Setting	Adjust the temperature within the vehicle. Auto button to keep the vehicle at the same temperature automatically.

QUICK START

NUMBER	BUTTON	DEFINITION
4	Air Flow Zones	Distribution of air to the selected air vents within the vehicle.
5	Heated Front Seat (OPTIONAL)	Independently controlled heated front seats with three temperature settings for both the driver and passenger.
6	Recirculation	Press to recirculate the air inside the vehicle.
7	Air conditioning	Switch on the air conditioning system.
8	Park Assist	Switch park assist passive or disabled.
9	Audio Mute / Volume	Rotate to increase and decrease the volume, press the mute button to mute the audio.
10	ECO Start / Stop	Switch start / stop on or off.
11	Window Demist Rear	Switch the demist rear on or off
12	Window Demist Front	Switch the demist front on or off
13	Hazard Warning Lamps	Switch on or off the hazard warning lamps

QUICK START

STEERING WHEEL CONTROLS

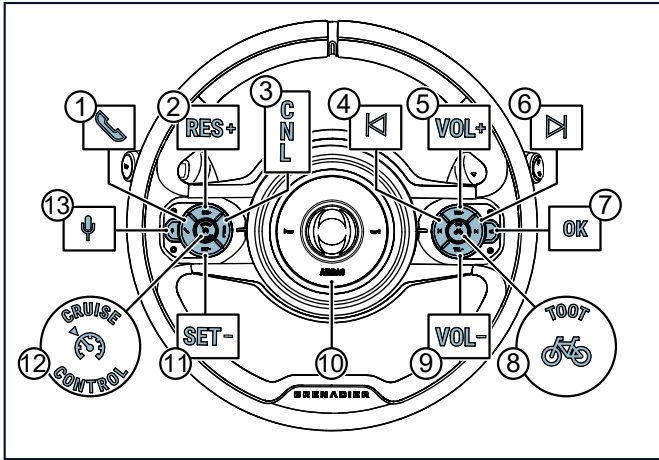

BUTTON	DEFINITION
1	Press to answer a phone call.
2	Resume speed or increase speed when using Cruise Control or Downhill Assist.
3	Cancel selection.
4	Skip to previous track or radio station. A long press will perform a track rewind or radio frequency change.

QUICK START

BUTTON	DEFINITION
5	Volume increase.
6	Skip to next track or radio station. A long press will perform a track fast forward or radio frequency change.
7	OK to select or confirm selection.
8	Warning tone for use around cyclists or pedestrians.
9	Volume decrease.
10	Main horn to warn others of the vehicle's approach or presence, or to call attention to a hazard.
11	Set speed or decrease speed when using Cruise Control or Downhill Assist.
12	Activates the Cruise Control into standby, ready to be set. Deactivates the Cruise Control.
13	Voice Recognition (Apple CarPlay® and Android Auto).

Horn and Toot Functions



WARNING: Do not use the toot function to alert other vehicles to your presence.

The horn , button (10) in the steering wheel controls above, is used to warn others of the vehicle's presence, or to call attention to a hazard.

The toot button , button (8) in the steering wheel controls above, activates a warning tone that is quieter than the standard horn feature. The purpose of the toot, is to politely alert cyclists or walkers of your presence.

QUICK START

HAZARD LAMPS

 *NOTE: When the ignition is switched off, the hazard warning lamps will continue to operate.*

Press the hazard warning lamp button (13), located on the centre console, to activate the hazard warning lamps.



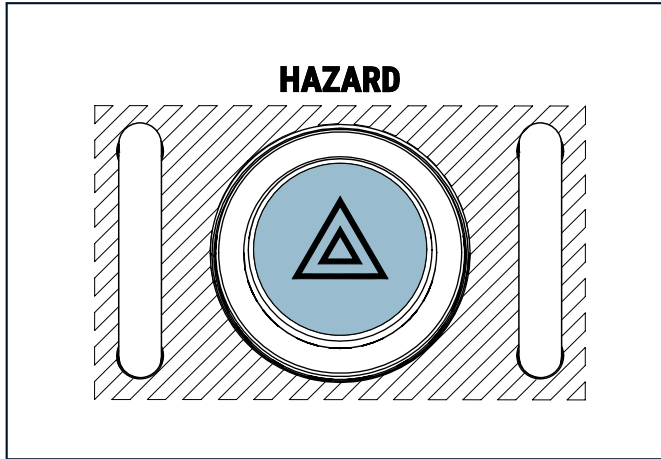







When the hazard warning lamps are switched on, all direction indicator signals will flash. Press the button (13) again, to switch the hazard warning lamps off.











TELL-TALE LAMPS

The tell-tale lamps are located on a screen behind the steering wheel. The lamps will illuminate when triggered depending on the feature or function they represent.











QUICK START

TELL-TALE	DEFINITION
	Indicator left
	Indicator right
	Exterior bulb failure - Shows when a lamp has failed. Have the system checked by an INEOS approved partner.
	Parking/side lamps
	Anti-locking brakes lamp will be illuminated if there is a fault or when the rear and/or front differentials are locked. If there is a fault, do not drive the vehicle and consult with an INEOS approved partner.
	Low beam
	High beam
	Front differential lock engaged
	Electrical charge
	Rear fog lights

QUICK START

TELL-TALE	DEFINITION
	Electronic stability control (ESC) off
	ESC permanently illuminated if there is a fault detected, blinks when actively supporting the driver. If there is a fault, do not drive the vehicle and consult with an INEOS approved partner.
	Diesel preheat
	Brake system fault - If there is a fault, do not drive the vehicle and consult with an INEOS approved partner.
	Parking brake
	Engine management system - If the lamp is amber consult with your nearest INEOS approved partner. If the lamp is red, stop driving immediately and consult with an INEOS approved partner to have the vehicle checked.
	Transmission failure - If there is a fault, do not drive the vehicle and consult with an INEOS approved partner.
	Turn signal trailer
	Seat belt warning - If there is a fault, do not drive the vehicle and consult with an INEOS approved partner.

QUICK START

TELL-TALE	DEFINITION
	Low tyre pressure warning
	Airbag warning - If there is a fault, do not drive the vehicle and consult with an INEOS approved partner.
	Off-road Mode/Wading Mode
	Center differential engaged
	Rear differential lock engaged
	Low gear indication
	Engine oil low
	Coolant temperature
	Steering system failure - If the lamp illuminates red, stop driving and consult immediately with an approved INEOS partner.
	Overall warning - Consult immediately with your nearest INEOS approved partner to have the vehicle checked.

QUICK START

Tell-Tale Lamp Colour

When the vehicle ignition is switched on, the tell-tale lamps may illuminate. This is the vehicle systems performing a functionality test.

The tell-tale lamps may illuminate when the ignition is switched on, when a function is activated or if there is a fault. The colour of the tell-tale lamps mean the following:

LAMP COLOUR	DEFINITION
Red	Danger and/or important reminder
Yellow	Fault and/or warning
Green	Confirmation of activation
Blue	Confirmation of activation
White	Confirmation of activation

CONNECTING PHONE DEVICE

If no phones are connected, the user can click on the device button and the settings page will appear directly.

To connect a new Phone, select 'Connect New Phone'. This will start the Bluetooth discovering mode and will show a list of available phones.



NOTE: If there are multiple devices with the same name, the system will display the name assigned with a number at the end. For example, If there are two phones connected, both called Sam's Phone, then they will be displayed as Sam's Phone and Sam's Phone-1.

Once a phone is selected, a security pairing PIN will appear on the infotainment screen. Match the security PIN on your phone to confirm connection.

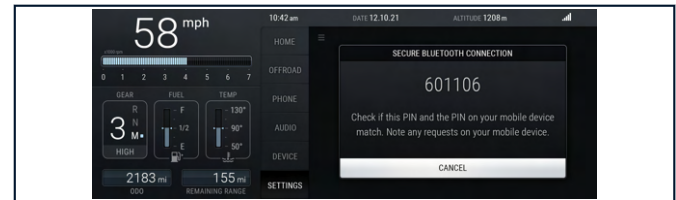

QUICK START

CONNECTING APPLE CARPLAY

 **NOTE:** Apple CarPlay requires IOS 13 and above to be compatible. IOS 12 and below may result in compatibility errors.

 **NOTE:** Hotspot should be set to on, for wireless Apple CarPlay to work.

After connecting the phone using Bluetooth , Apple CarPlay will be displayed automatically. If the phone is being connected for the first time, there will be a intermediate screen asking the user to agree to the privacy policy.

If the connection fails, a message will be shown on the infotainment screen.

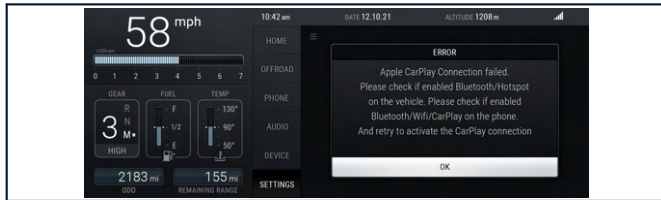

If a device connected to the infotainment system supports wireless Apple CarPlay , then you will be asked to connect once the phone device has been paired.

If there is already a wireless Apple CarPlay connection or a wired Android Auto connection, at the time of connecting the USB connection, a prompt will show on the screen, from which you can switch to the newly connected device.

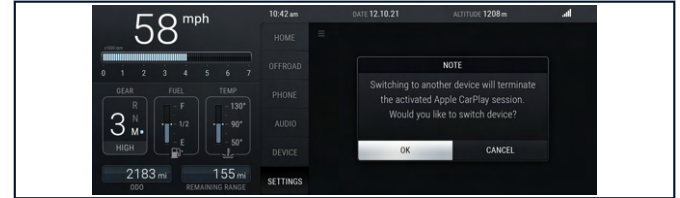

QUICK START

CONNECTING ANDROID AUTO

To connect your device to access Android Auto, follow this procedure:

1. Connect the device using a USB-C connection.
2. A pop up message will be displayed on the infotainment screen, asking the driver to 'stop the car and follow instruction on your phone'.



3. A message will pop up on the phone device, instructing the user on how to connect.
4. Once the instructions have been followed and completed on the phone device, press 'OK' on the infotainment screen.
5. If the connection has failed, then press the 'OK' button on the infotainment screen and start again from the beginning of the procedure.
6. The 'DEVICE' menu tab will now change to the Android Auto symbol, confirming the connection.

BEFORE DRIVING

SEATING	34
OCCUPANT RESTRAINT SYSTEM	40
SEAT BELTS	41
AIRBAGS	46
CHILD SAFETY	49
ISOFIX AND I-SIZE ANCHORS	53
CHILD SEAT WITH SEAT BELT INSTALLATION	56
CHILD DOOR LOCKS	57

BEFORE DRIVING

SEATING

Correct Driving Position

 **WARNING:** Make sure the seat is correctly adjusted before you drive the vehicle.

Before driving, review the following list of suggestions on how to position the drivers seat correctly:

- > Make sure your seat is high enough to give you a good view of the road, while still allowing clearance above your head. Your hips should be at least as high as your knees.
- > Move the seat until you can easily push down the pedals fully.
- > Make sure your thighs are supported without pressure around your knees.
- > Check the angle of the seat back rest and adjust to a comfortable driving position.
- > The steering wheel is adjustable, make sure you can reach it easily and that it does not obstruct your view of anything vital on the dashboard.
- > Adjust the head restraint, so that it is as high as the top of your head and as close to the rear of your head as possible to avoid whiplash injuries.
- > Buckle your seat belt and make sure it is adjusted correctly so it is tight, with the lap belt over the pelvic

region and the diagonal strap over the shoulder, not the neck. Pregnant women should put the lap belt flat on their thighs beneath their abdomen.

Front Seat Adjustment

 **WARNING:** Do not adjust the driver's seat while driving. The seat might adjust in the wrong direction or a distance much greater than expected. The driver might lose handling of the controls, this will result in a crash, injury or death.

 **WARNING:** Never store any objects under or around the seats. If objects move and become trapped around the pedal controls, then this may lead to a crash. This excludes the INEOS supplied toolkit, that has been designed to be secured under the seat safely.

 **WARNING:** The seats must be firmly adjusted and locked into place once a comfortable driving position has been found. Check the seat is positioned correctly after adjusting, before driving the vehicle. Failure to do this might result in the seat moving unexpectedly while driving.

Both the driver and front passenger seats are fully adjustable. The occupants can raise the seating height, fore and aft position, as well as the angle of the backrest to ensure the occupants are safe and comfortable.

BEFORE DRIVING



CAUTION: Immediately dry the seats and the front seat mechanisms and sliding rails, if they are exposed to water during the interior washing process.

Seat Inclination

To adjust the seating height, pull the height adjustment lever upwards to raise the seat position. Using the same lever, push downwards to lower the seating position. The lever will need to be pulled or pushed several times, until the desired position is achieved.

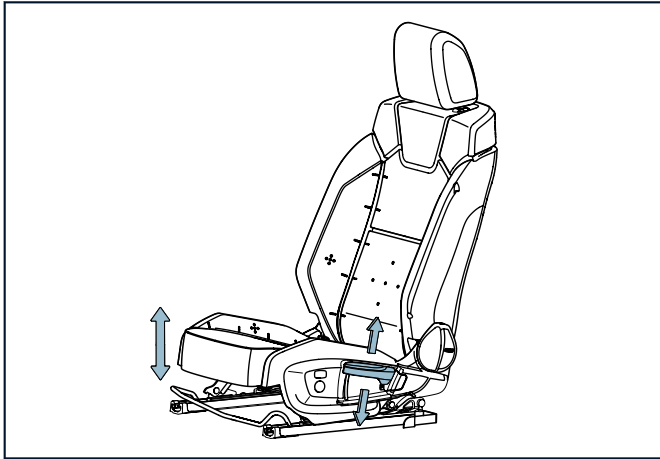

Longitudinal adjustment



WARNING: Do not sit nearer than 25 cm to the steering wheel. This will allow safe operation of the steering wheel airbag.

Lift the bar upwards, to slide the seat forward or backwards.



NOTE: Be sure the seat is secured into position before driving.

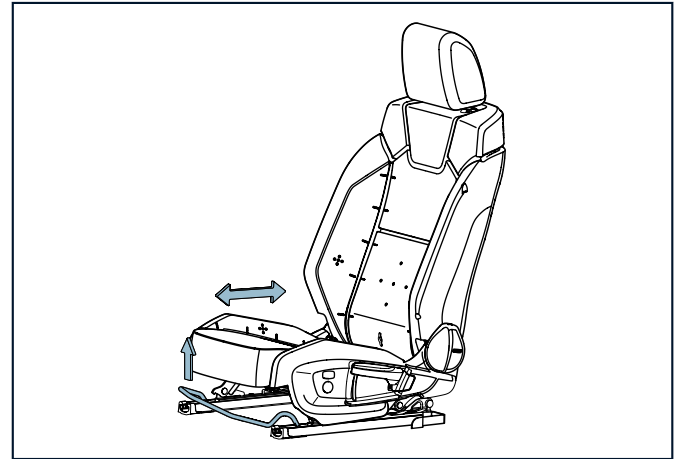

BEFORE DRIVING

Backrest Angle Adjustment



WARNING: Do not adjust the seat backrest too far back. This can cause the seat occupant to slide under the seat belt, resulting in injury or death in the event of a crash.

Use the control lever to adjust the angle of the backrest. To adjust the backrest backwards or forwards, turn the lever towards the back of the vehicle and lean against the backrest until correctly positioned.

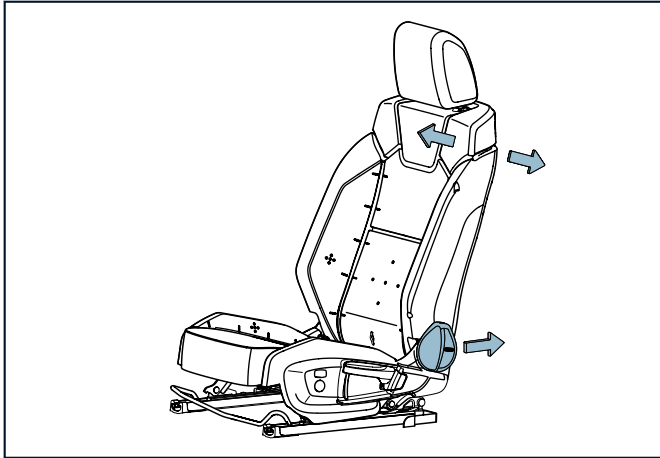

Front Head Restraints

The front head restraints are removable. To remove the head restraint, push the control button inwards at the base and pull the head restraint until fully detached.

To install the head restraint, push the control button inwards and push the head restraint into the location holes in the top of the seat.

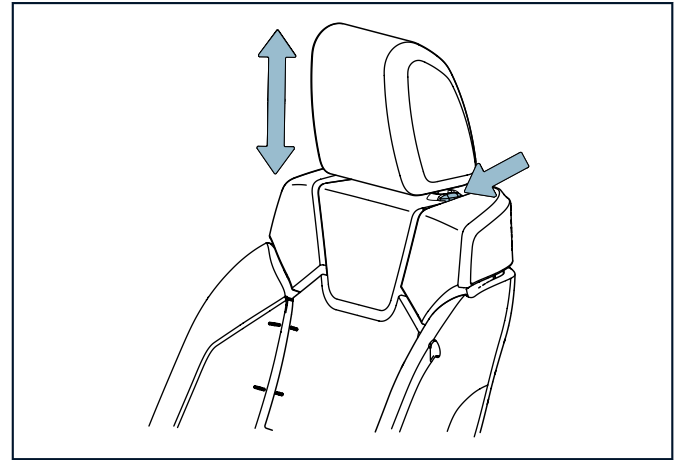

BEFORE DRIVING

Rear Head Restraints

 **WARNING:** Children should not adjust or remove the headrest unless specifically instructed to.

All head restraints are removable. To remove the head restraint, push the control button inwards at the base and pull the head restraint until detached.

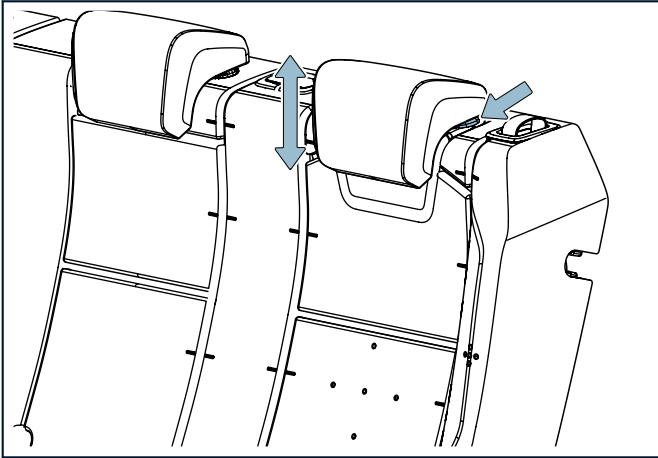

To install the head restraint, push the control button inwards and push the head restraint into the location holes on the top of the seat.

Head Restraint Adjustment

 **WARNING:** The adjustable head restraint is a safety device. Whenever possible it should be installed and properly adjusted when the seat is occupied. Failure to adjust the head restraint properly could reduce its effectiveness during certain impacts.

To adjust the head restraint, pull the head restraint upwards until the head restraint is in a comfortable position. To lower the headrest back down, push the control button at the base of the

BEFORE DRIVING

headrest. Make sure the head restraint is locked into position before driving the vehicle.

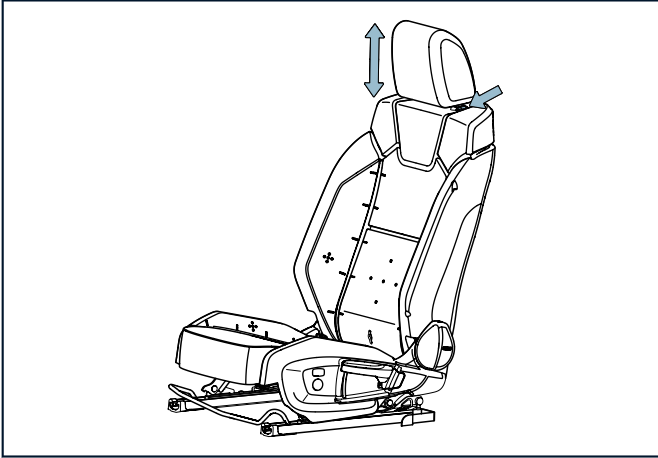

Folding Rear Seats



NOTE: INEOS recommends lifting and tilting the lower cushion forward and removing the headrest to lie the back support section down flat. This protects the headrest once stored away and the lower cushion provides protection to the front seats.



WARNING: Always check the seat belt buckle is not trapped when lifting and tilting the lower cushion. If the seat belt is trapped when lifting this can cause injury to occupants or damage to the seating.



CAUTION: Before folding the back support section of the seats make sure the seat belt buckle is situated inside the storage slot. Failure to do so can cause damage to the seats and the seat belt buckle.



CAUTION: Do not fold the rear seats when hosing down the loadspace. The rear seats must be upright when hosing.

The rear seats are split into a 60:40 divide and can be folded down.

There are two options when folding the rear seat, the first option is to fold the rear back support section forwards to lie flat on top of the lower cushion. The second method is to remove the headrest, followed by folding the bottom cushion of the seat

BEFORE DRIVING

towards the front of the vehicle (1) and pull the loop located above the single outer seat (2).

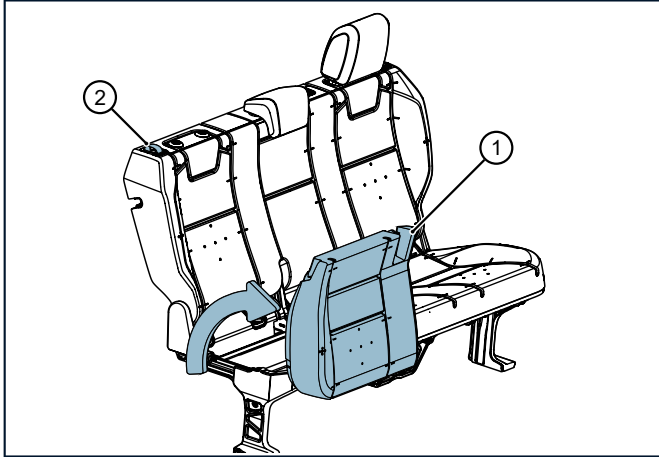

Fold the backrest forward to collapse the seat (3).

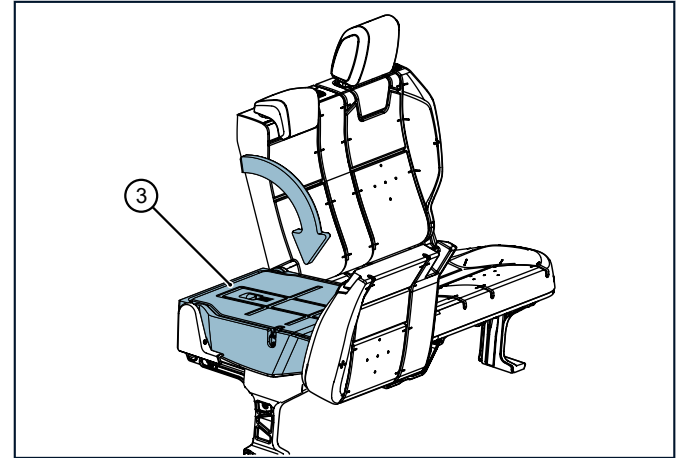

WARNING: When unfolding the seats back into position for use as a seat, you must make sure the seat is locked into position. There will be a red indicator near the loop strap when the seats are not locked into place. When the red indicator is not visible the seat is in the locked position. Always try to move the seats, even when there is no red indicator.



WARNING: Move the seat belt away from the seat when folding the back support section back into an upright

BEFORE DRIVING

position. This stops the seat belt being caught on the back support section.



WARNING: Be careful to not trap your hands or arms between the seat, interior and the catch when you lock it into position.

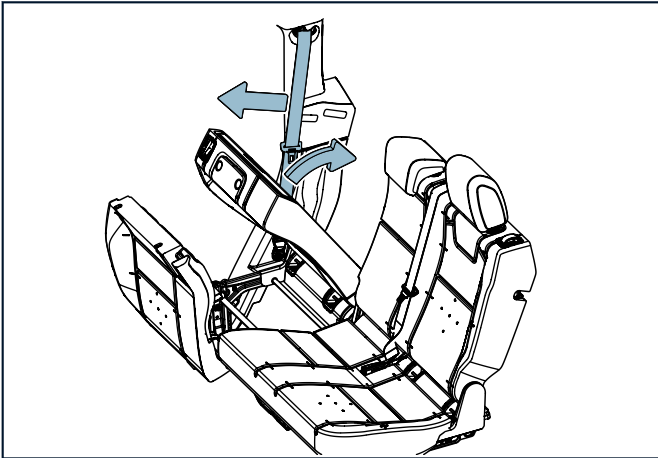

NOTE: The seats should always be upright for the interior cleaning process.

OCCUPANT RESTRAINT SYSTEM

The Occupant Restraint System is designed to protect the occupants of the vehicle in a variety of impact conditions.

The system consists of:

- > Driver and front passenger safety belts with pretensioner(s) and load limiting systems.
- > Rear seat belts.
- > Dual stage driver and passenger airbags.
- > Curtain airbags on both sides of the vehicle.
- > Thorax airbags both sides of the vehicle. (Driver and front passenger only)

The vehicle is fitted with an Airbag Control Module (ACM) to measure the seat occupancy conditions. Using a deployment matrix, the ACM calculates if and where the airbags need to be deployed.

In the case of a crash, the ACM will determine the necessary restraint system to be activated. If the Airbags or pre-tensioner(s) do not operate in a collision it does not mean there is something wrong with the system. The ACM will take all readings and information into consideration, along with the vehicle conditions at the time of the accident. This may result in the conditions not being appropriate to trigger the operation of any stages of airbag deployment, seat belt pre-tensioner(s) and other safety devices.

BEFORE DRIVING

The airbags locations in the vehicle are highlighted by an 'AIRBAG' imprint or marker around the interior. For example, the steering wheel has 'AIRBAG' imprinted into the centre section.

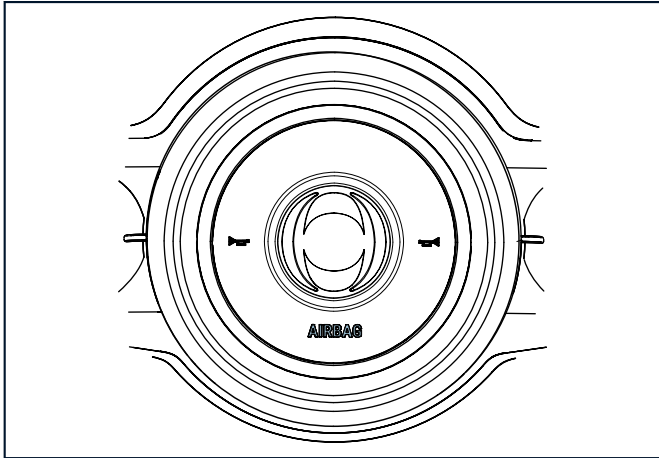





Determining if the System is Operational

The airbag system warning symbol  is shown in the tell-tale instrument cluster to provide the condition of the system, once the ignition is set to ON. If the airbag system warning symbol illuminates while driving, then this is signaling a fault with the

airbag system. A warning message will be displayed on the infotainment screen with a description of the fault.

If either of these conditions occur, even intermittently, have the restraint system inspected by your INEOS approved partner immediately. Unless investigated and repaired, the system may not operate correctly in the event of an incident such as a crash.

SEAT BELTS

-  **WARNING:** It is essential to wear your seat belt. Not wearing a seat belt increases the chance of serious injury or death in the event of an accident.
-  **WARNING:** Seat belts should not be twisted. This may result in injury when heavy braking.
-  **WARNING:** Never place the shoulder section of the seat belt behind your back or under your arm. In the event of an accident or sudden braking, this may lead to injury.
-  **WARNING:** Belts are designed for adults. Therefore infants and small children must be restrained in approved child safety seat restraints.
-  **WARNING:** Keep the seat belts well maintained and where possible, avoid contact with sharp objects and edgings. Failure to do this, will result in the webbing of the seat belt cutting or abrading, weakening the belt. This may lead to seat belt failure, during heavy braking

BEFORE DRIVING

or during an accident, causing serious injury or even death.



WARNING: Each belt assembly must only be used by one occupant. It is dangerous to put a belt around a child being carried on the passenger's lap. Do not put an adult seat belt around two children.



WARNING: It is essential that all the passengers are correctly seated with the required restraints in place, for their own safety and the safety of others in the vehicle. Even with airbags, injuries and possible death can occur if seat belts are not worn correctly.



WARNING: Reclining the seat back can significantly decrease the protection provided by the seat belt in the event of an accident. Adjust the seat back to an upright position. Make sure that the seat back is locked in place, otherwise it could move forward in the event of a sudden stop or crash and cause injury.



WARNING: Seat belts are designed to bear upon the bony structure of the body, and should be worn low across the front of the pelvis, chest and shoulders. Wearing the lap section of the belt across the abdominal area must be avoided.



WARNING: Always remove rigid or breakable objects such as spectacles or a mobile phone, from your

pockets. These items could be trapped under seat belts, possibly causing injury in the event of an accident.



WARNING: Expectant mothers should seek medical advice on the most appropriate way to wear the seat belt.



WARNING: No modifications or additions should be made by the user which will either prevent seat belt adjusting devices from operating, or prevent seat belt assembly from being adjusted to remove slack. Never install accessories on your seat belts.



WARNING: Once the seat belt is engaged, make sure the belt is as tight as possible without causing discomfort, eliminating any unnecessary slack to provide the protection for which they have been designed.



WARNING: The use of seat belt dummies is forbidden. Do not use seat belt dummies.



WARNING: The entire seat belt assembly should be replaced if subject to an accident or crash, even if there are no clear signs of wear or impact damage.



WARNING: If it is necessary to replace a seat belt on this vehicle, then it **MUST** be replaced with an approved seat belt. The approved seat belts for the front seats must also include a load limiting system.

BEFORE DRIVING



CAUTION: Seat belts must be kept clean, to ensure the retraction device works correctly. Make sure that belt webbing is not twisted, looped, frayed or obstructed in any way. If in doubt about condition or operation of seat belt restraints, seek help and advice from an INEOS approved partner.



CAUTION: Seat belt webbing can become contaminated or damaged from exposure to substances such as polishes, oils and chemicals and particularly battery acid. If the seat belts do require cleaning, it is recommended to only use mild soap and water. If the belt webbing does become frayed, contaminated or damaged then a replacement should be installed.

Pre-tensioner and Load Limiting

There are pre-tensioners and load limiting systems installed on the front seat belts for safety purposes.

The pre-tensioners reduce the slack in the seat belts after frontal or near frontal impacts. The pre-tensioners are designed to keep the occupants in position within the seats to avoid forward displacement. The belt force limiter will reduce the pressure on the occupants when the shoulder strap registers a force greater than a certain limit, reducing stress on the occupants, to avoid seat belt related injuries in a sudden stop or collision. Once the belt force limiter has been triggered, a forward displacement of the occupant takes place, so that the frontal airbags take over a larger part of the restraint effect.



NOTE: In some moderate frontal or rear accidents, only the pre-tensioner system will deploy.

Seat Belt Fastening



NOTE: The seat belt may lock if parked on an incline as the seat belt webbing is withdrawn. If the mechanism does lock gently release the tension on the belt and slowly guide the belt webbing until the belt is fully withdrawn into place.

All seats in the vehicle, are equipped with three point inertia reel seat belts.

1. The front seat belts enter and exit from the interior B-pillar. The rear seat belts enter and exit from the top of the rear seat back rest.
2. Seat belt anchor point.
3. Belt buckle latch location.

BEFORE DRIVING

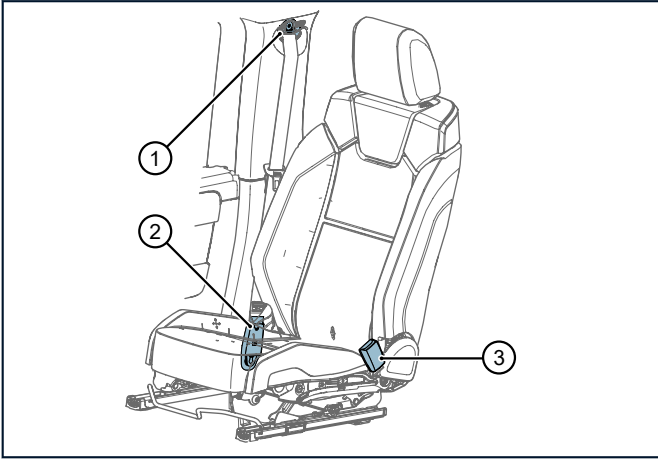

The inertia seat belt reels are designed to automatically apply tension to the belt when necessary for safety with comfort, but the reels will lock under severe braking or in the event of a collision.

To test the seat belt and the locking feature of the inertia belt reels, quickly pull the seat belt strap forwards. The seat belt should lock as you are replicating a sudden movement of force, such as, sudden braking. If the locking mechanism does not lock the seat belt in this test you should consult your recommended INEOS approved partner.

To fasten the seat belt, pull the seat belt out over the shoulder ensuring you have grip of the seat belt buckle tongue. Pull across the chest and down towards the seat belt buckle latch.

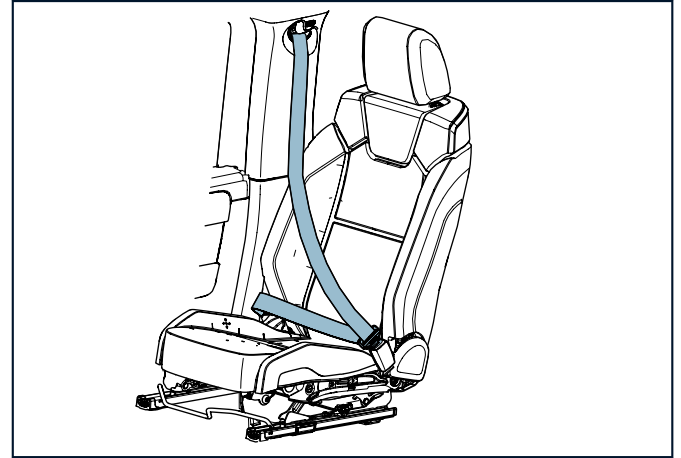

BEFORE DRIVING

Push the seat belt buckle tongue into the buckle latch until you hear a click.

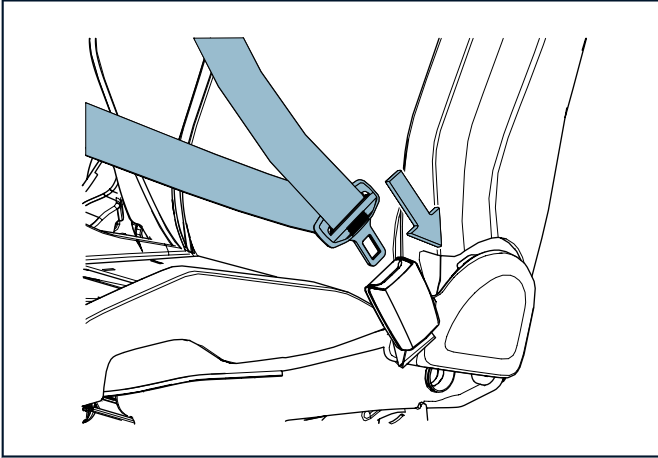

NOTE: It is advised to pull the seat belt down, across the body, after a positive click is heard, this is to ensure that the seat belt is correctly latched, inside the buckle.

Seat Belt Reminder

The seat belt reminder warning symbol  illuminates in the tell-tale cluster, along with an acoustic warning sound, to signal that an occupied front seat has a disengaged seat belt.

The seat belt reminder will be activated if the vehicle reaches a speed of 15mph (25km/h). The acoustic signal will be heard for 93 seconds.

The back seat warning symbol  will illuminate and an acoustic signal will be heard if any of the rear seatbelts are unbuckled whilst the vehicle is motion.

Seat Belt Unfastening



WARNING: Do not allow the belt to twist when retracting to the stored position.



WARNING: All passengers, including the driver, should always wear seat belts, whether or not an airbag is provided, to decrease the risk of injury or death in the event of a crash



CAUTION: Always guide the retracting seat belt webbing to the stored position to avoid the seat belt buckle tongue hitting interior surfaces or windows.

BEFORE DRIVING

Grip the seat belt buckle tongue and push the button on the buckle latch to release. Take care gently guiding the seat belt webbing to slowly retract to the original stored position.

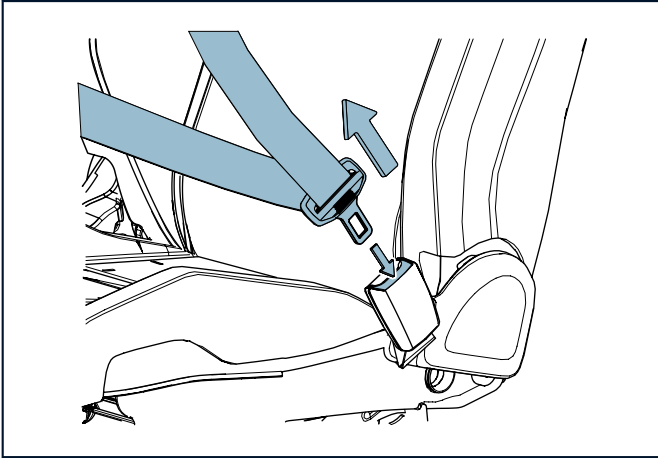

WARNING: Never use a rearward facing child restraint on a seat protected by an active airbag in front of it, death or serious injury to the child can occur.

The Airbag System, is designed to protect all occupants in the event of sudden braking or a serious impact. The airbags work in conjunction with the seat belt pre-tensioners to ensure the airbags will deploy during a serious frontal impact.

AIRBAGS



WARNING: Read and understand the airbag safety labels to comply with the instructions before driving.

BEFORE DRIVING

Airbag safety labels, are located within the vehicle for the attention of all occupants. Read and understand the airbag safety labels, to comply with the instructions before driving the vehicle.

1. The driver's airbag is located in the steering wheel (1).

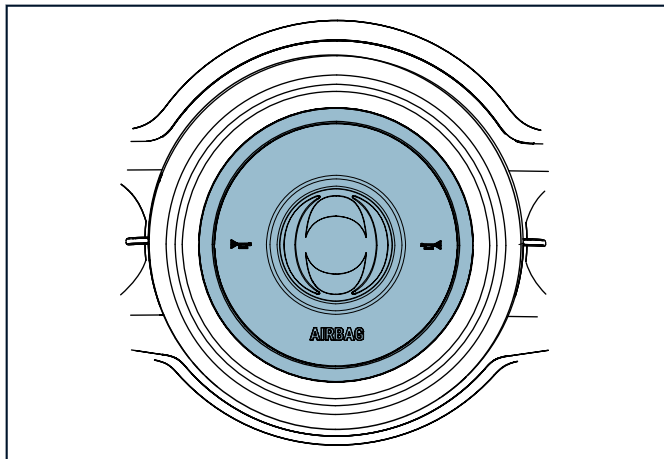

2. The passenger airbag (2), is located on the upper glove compartment.
3. The side thorax airbags (3), are located in the front driver and passenger seats.
4. The curtain airbags (4) are located in the roof trim.

5. The knee bolster airbags (5) (if applicable), are located under the dashboard.

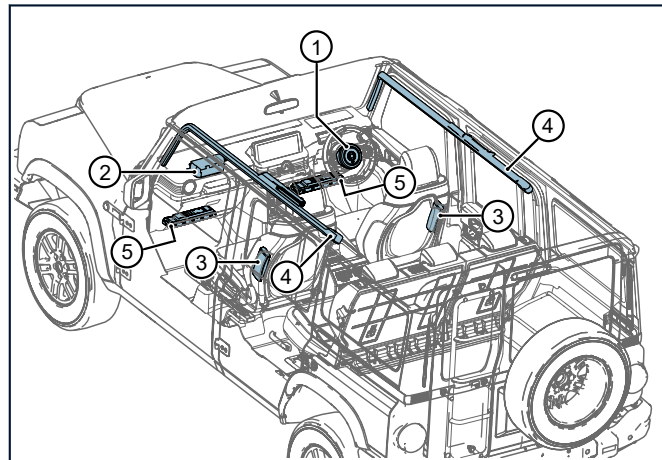

Airbag safety labels are located on the front passenger sun visor. The instructions on these labels must be read and understood before driving the vehicle.

Airbag Deployment





WARNING: Improper handling or tampering could result in accidental deployment of the airbags, resulting in injury or death.

BEFORE DRIVING

 **WARNING:** The use of third party accessory seat covers may prevent the deployment of the seat side airbags and increase the risk of injury in an accident.

 **WARNING:** All passengers, including the driver, should always wear seat belts, whether or not an airbag is provided, to decrease the risk of injury or death in the event of a crash.

 **WARNING:** No objects should be attached to, or placed on, the centre cover of the steering wheel or the front passenger fascia panel. Such objects could cause harm if the vehicle is in a collision severe enough to cause the airbags to deploy.

 **WARNING:** There may be potential for minor friction injury when the airbags deploy. This may be caused by contact from the rapidly deploying airbag with bare skin.

 **WARNING:** If an airbag deploys, there is a chance of temporary hearing loss due to the noise as a result of the airbag deployment.

 **WARNING:** Avoid touching safety restraint components immediately after deployment, as there is a risk of sustaining burns.

 **NOTE:** The airbag system is not designed to protect against rear impacts.

The airbag system is designed to provide additional protection. However, the airbags do inflate within a few thousandths of a second and with considerable force. There is therefore, a risk of death or serious injury. The risk of injury is heightened if the passengers are not seated correctly in the correct position or are not restrained correctly from improper use of the seat belts when the airbags deploy.

The system will not deploy in the event of minor frontal or side impacts, such as minor impacts when parking.

When maintenance is required near to an airbag, seek advice from an INEOS approved partner. Failure to do so, can cause inadvertent airbag deployment.

Airbag Malfunction

 **WARNING:** In the case of an active airbag warning light, do not install child restraint systems on the front passenger seat.

The vehicle will self test upon start up. The airbag warning lamp  will be illuminated for up to 10 seconds and switch off to confirm no faults identified. If after six seconds the airbag warning lamp is still illuminated then there is a confirmed fault with the airbag system. Immediately seek professional advice from your nearest INEOS approved service center.

BEFORE DRIVING

CHILD SAFETY

The following points are strongly recommended by INEOS for the safety of children when traveling:

- > Children, should sit in the rear passenger seats.
 - > Children should always be restrained using the correct restraint method, regardless of their age when traveling in the vehicle.
 - > Always use ISOFIX / i-Size anchors where available.
-  **WARNING:** Never use a rearward facing child restraint on a seat protected by an active airbag in front of it, death or serious injury to the child can occur.



-  **WARNING:** A suitable child restraint, correctly installed and used, provides the highest degree of protection for infants and small children in most accident situations.

-  **WARNING:** The passenger airbag must be deactivated when using a child seat restraint on the front passenger seat. If not, the triggering of the airbags poses a risk of fatal injury to the child. This is especially the case if rear facing child restraint systems are used on the front passenger seat.

-  **WARNING:** The seat belt reminder function is only designed to recognise an adult sized occupant and will not be activated by a child seat. If a child seat is to be secured to the front passenger seat with a seat belt, make sure it is correctly installed in accordance with the manufacturer's instructions. A child seat that is not correctly restrained can cause an infant or child to be seriously injured or killed in a crash.

-  **WARNING:** Do not allow children to travel in a vehicle without being correctly restrained. An appropriate child seat or harness should always be used.





-  **WARNING:** Each seat belt assembly must be used by only one passenger. Putting a seat belt around a child being carried on a passengers lap is dangerous.

-  **WARNING:** When using child seats, make sure the installed child seat does not rest or lean against the interior door or windows to avoid injuries when traveling.

BEFORE DRIVING

i *NOTE: Do not cover the child restraint systems with items or materials and do not affix items to the child restraint systems.*

Child Restraint System Seating

SEAT NUMBER	SEAT POSITION	MARKING	NOTICE
1	Front passenger seat	 U	(1), (2), (3)
2	Rear seat, left side	 U 	(2), (3)
3	Rear seat, center	U	(2), (3)
4	Rear seat, right side	 U 	(2), (3)

i *NOTE: The table above applies to both left and right hand drive. Seat positions 1, 2, 3 and 4 remain as the same seats, regardless of right hand or left hand drive.*

Definitions of the markings within the 'Child Restraint System Seating' table:

 = It is suitable for i-Size and ISOFIX child restraint system.

 = This seat is equipped with a top tether anchorage point.

 = Never use a rear-facing child restraint system on the front passenger's seat when the front passenger airbag is activated.

U = It is suitable for a universal category child restraint system to be fixed with the vehicle seat belt.

BEFORE DRIVING

Descriptions for the 'NOTICE' column inside the table:

(1) = Move the front seat fully rearward.

(2) = When you install a front-facing child restraint, if there is a space between the child restraint and the backrest, adjust the backrest angle in order to install the child restraint system properly.

(3) = If the head restraint interferes with the child restraint system, adjust the height of the head restraint or remove it, as necessary.

Detailed Information for Child Restraint System

DESCRIPTION	SEAT POSITION NUMBER				
	1 (FPA Activated)	1 (FPA Deactivated)	2	3	4
Seating position suitable for universal belted (YES/NO)	NO	YES	YES	YES	YES
i-Size seating position (YES/NO)	NO	NO	YES	NO	YES
Seating position suitable for lateral fixture (L1/L2)	NO	NO	X	X	X
Suitable rear-facing fixture (R1/R2/R3)	NO	NO	R1, R2	NO	R1, R2
Suitable front-facing fixture (F2X/F2/F3)	NO	NO	F2X, F2, F3	NO	F2X, F2, F3
Suitable booster fixture (B2/B3)	NO	NO	B2, B3	NO	B2, B3

Key for the table:

YES = Suitable for the seating position description.

NO = Not suitable for this seating position.

BEFORE DRIVING

X = ISOFIX position is not suitable for ISOFIX child restraint systems in this fixture.

FPA = Front Passenger Airbag.

Child Seat Belt Fastening

 **WARNING:** Seat belts are designed for adults, so infants and smaller children need to be restrained in an approved child safety seat. An infant or child that is not correctly restrained can be seriously injured or killed in a crash.

The upper webbing strap should be positioned across the child's rib cage and hips, keeping the child safe but comfortable. It is important the lap webbing strap is positioned across the thighs, bearing on the pelvis but not on the abdominal area.

The seat belt webbing should be positioned as advised, over the body parts that are most capable of taking force from any impact.

Passenger Airbag Deactivation

 **WARNING:** If the passenger airbag is showing as deactivated but the airbag warning lamp is on, then do not allow adults or children to use the passenger seat. Consult immediately with an INEOS approved partner.

The passenger airbag lamps (A) are located on the overhead control panel.

During the start up of the vehicle all the passenger airbag lamps will be illuminated as the vehicle is self testing.

If the passenger airbag is active after the self testing has finished, then the 'ON' lamp and the text 'PASSENGER AIR BAG' will be illuminated for up to 60 seconds. At this point there will be no lamp or text illuminated and the passenger airbag stays active.

If the passenger airbag is deactivated after the self testing process has finished, then the 'OFF' Lamp and the text 'PASSENGER AIR BAG' will be illuminated continuously to indicate that the passenger air bag is deactivated.

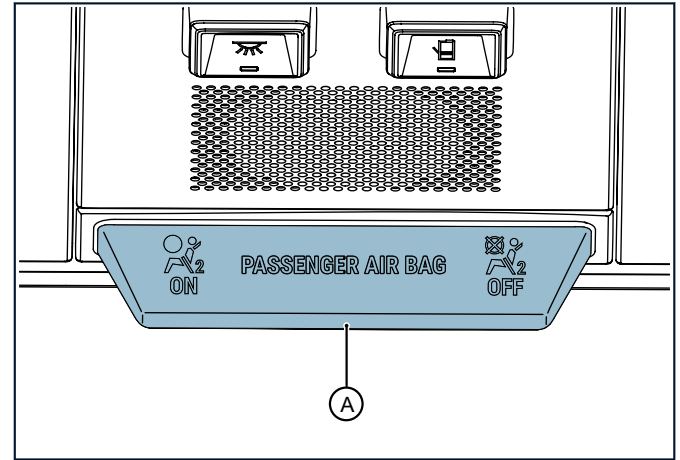

BEFORE DRIVING

To deactivate the passenger airbag make sure the handbrake has been engaged and the vehicle is in gear park (P). Do not press the brake pedal at this time.

Press the 'Passenger Airbag' button using the infotainment system. This will then prompt you to press the brake pedal for three seconds. You will receive a confirmation on the infotainment system that the airbag has been disabled.

If there is no confirmation, do not assume the airbag is deactivated. Try the process again from the beginning. If the confirmation fails to appear again then contact an INEOS approved partner and do not install any child restraint to the front passenger seat.

Child Seat and Front Passenger Airbag



WARNING: Never put a child in a child seat or on a booster cushion on the front passenger seat if the airbag is set to on.



WARNING: Do not deactivate the front passenger airbag unless you are installing a child seat on the front passenger seat. Always activate the passenger airbag when the child seat is removed from the front passenger seat. Failure to switch on the front passenger airbag when used by an adult after the child seat has been removed will result in the occupant not receiving full protection of the airbag. Serious injuries or death could occur.

The airbag system is designed to deploy, to provide additional protection for the front seat occupants in serious frontal or side collisions.

ISOFIX AND I-SIZE ANCHORS



WARNING: Always make sure the child seat is correctly secured in place according to the manufacturer's instructions. An unsecured child seat is dangerous. In a sudden stop or a collision it could move, causing serious injury or death to the child or any other passengers.



WARNING: Make sure the seat and anchor points are clear of items or obstructions, when installing the child seat. Failure to do this will prevent the child seat from being correctly and securely installed to the ISOFIX / i-Size (International Standards Organisation FIX) anchor points.



WARNING: If the child seat is not secured correctly to the ISOFIX / i-Size anchors then sudden braking or a collision could cause the seat to move resulting in serious injury or death to the child or passengers.



WARNING: Make sure that the child seat tether strap is always used, when installing a child seat with ISOFIX / i-Size anchors.

BEFORE DRIVING

Rear Seat ISOFIX/i-Size

The vehicle is equipped with ISOFIX/i-Size anchors for the use of child seats on the rear passenger seats. The anchor points (A) are located between the seat base and the seat back, in both the outer rear seats.

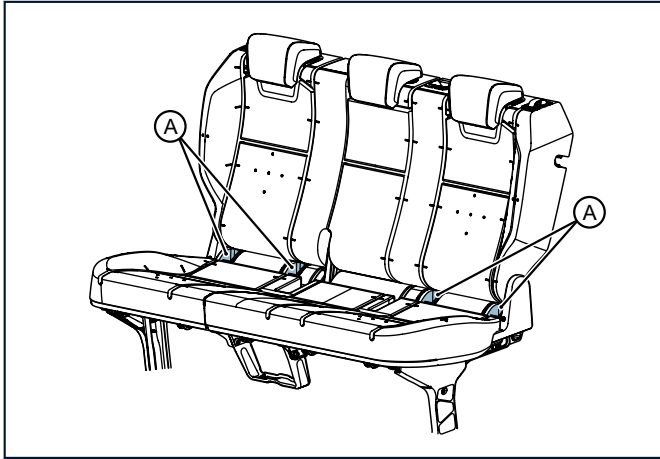



TABLE 1: ISOFIX and i-Size Identification

ISOFIX	i-SIZE
	

Tether Anchor Points







WARNING: Make sure the child seat tether strap is always used when installing a child seat to ISOFIX / i-Size anchors.



WARNING: Never use the child restraint anchor points to hold down or secure items. The tether anchor points should only be used to secure children and child seats. Adults should not rely on these anchor points and should use the adult restraint systems provided. The child restraint anchor points are designed to withstand only those loads imposed by correctly installed child restraints.

BEFORE DRIVING

-  **WARNING:** Follow the manufacturer's instructions when installing child seats to ensure correct fitment and positioning. Failure to do this is dangerous.
-  **WARNING:** The tether strap should always be free from obstructions. Do not place any items on the tether strap between the child and the tether anchor point. It is very important not to install the tether strap over the child. If the item or obstruction moves during travel, the tether strap can become loose and much less effective in a collision.
-  **WARNING:** Always make sure any child seat installed is secured into place before traveling. An unsecured child seat could cause serious injury or even death.
-  **WARNING:** Make sure seat belts are moved out of the way when installing child seats to the ISOFIX / i-Size anchors. Otherwise it prevents the child seat from being securely attached to the ISOFIX / i-Size anchors.

Tether straps are designed to reduce the movement of a child seat in the event of sudden braking or in the event of a collision. The

tether strap connects the top section of the child seat to the tether anchor located on the back section of the rear outer seats.

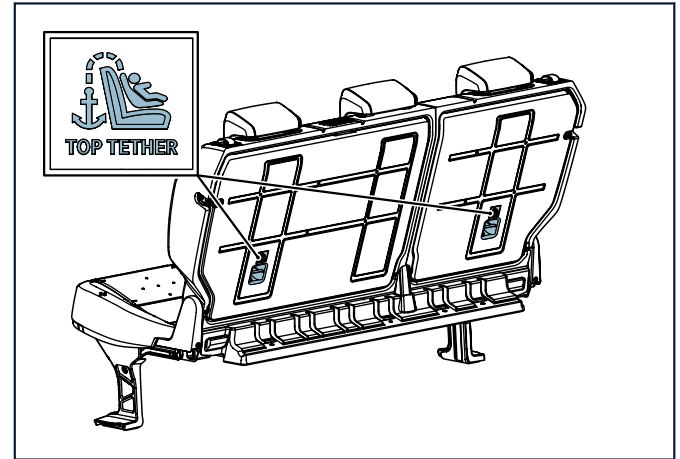

To fasten the tether strap to the tether anchor in the back of the rear seats, the tether strap must run between the headrest rods on top of the seat, resting under the headrest itself. Ensure there is no slack in the tether once attached.

The tether anchor points can be identified with the symbol .

BEFORE DRIVING

CHILD SEAT WITH SEAT BELT INSTALLATION



WARNING: Seat belt installed child restraints are designed to be secured by the lap belt and shoulder portion of the safety belt. If the child restraints are not properly secured then children could be at severe risk of injury or death in the event of sudden braking or a collision.



WARNING: When installing a child seat follow the manufacturers instructions for correct installation process. Not following the child seat manufacturers instructions when installing the child seat is dangerous and can lead to injury or death in sudden braking or in the event of collisions.

To install a child seat to the front seat using the seat belt, please follow the procedure provided:

1. The passenger airbag must be deactivated for the safety of the child.
2. Move the passenger seat rearward and recline the back of the seat to create space.
3. Follow the child seat manufacturer's instructions and install the child seat into the passenger seat. It is important to follow the manufacturer's instructions for the safety of the child using the child seat.
4. Adjust the back section of the passenger seat until the child seat is supported and secure.

The vehicle is installed with a Automatic Locking Retractor (ALR) system to secure child seats into place once installed. The ALR system will temporarily lock the seat belt to secure the child seat in place.

Automatic Locking Retractor

The automatic locking retractor (ALR) system, is designed to only operate once the seat belt has been fully extended. Only when the seat belt has been pulled to the maximum extension point, should the belt be used, to secure the child seat.

Using the belt latch, thread the seat belt through the child seat correctly and engage the belt latch into the seat buckle.

Once the seat belt is engaged, it is important to gently remove the slack from the lower belt. Then allow the upper belt strap to retract, until there is no slack. When the upper belt is retracting you should hear a "clicking" sound as the seat belt retracts.



WARNING: Always check the child seat is secure after installation.



WARNING: Always pull on the upper seat belt strap after the belt has retracted, to check that the ALR lock has engaged.



NOTE: When parked on an incline, the seat belt may lock as it is withdrawn. This is not a fault. If the mechanism locks, release the seat belt tension and then pull the seat belt very gently to avoid operation of the inertia lock.

BEFORE DRIVING

Upon removal of the child seat, the seat belt should be fully retracted into a disused position, doing this will disengage the ALR system to make the ALR system safe and ready for use by other adult occupants.

i *NOTE: Once the ALR system has been disengaged, it is important to always repeat the process, of fully extending the seat belt to re-engage the ALR system when reinstalling the child seat.*

CHILD DOOR LOCKS

! **WARNING:** Use the child locks when children are occupying the rear seats.

! **WARNING:** The central locking function is **NOT** a child lock.

The vehicle is installed with child locks inside the rear doors only. They are designed to stop children opening the doors from inside the vehicle. In the image below, position (A), indicates the child

locks are activated. Position (B), indicates that the child locks are not activated.

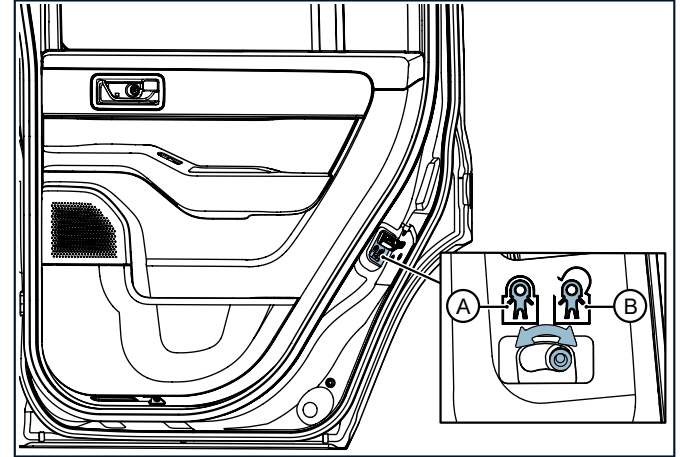

VEHICLE OPERATION

VEHICLE ENGINE RUNNING-IN	59
STARTING AND STOPPING THE ENGINE	59
STEERING WHEEL CONTROLS	24
WINDOWS AND MIRRORS	63
INTERIOR LAMPS	67
EXTERNAL LAMPS	69
WIPER AND WASHER SYSTEM	75
HANDBRAKE	80
DRIVETRAIN	81
VEHICLE LOADING	91
FUELLING	94
PARTICULATE FILTERS	97

VEHICLE OPERATION

VEHICLE ENGINE RUNNING-IN

Proper running-in of both the petrol and diesel engines is essential to ensure the best possible reliability of the engine and vehicle components throughout the vehicles life.

It is essential, to drive with consideration for the first 500 miles (800 km) to ensure the engine, gearbox, brakes and tyres have had time to bed-in. INEOS recommends the following for the running-in process:

- > Do not over stress or strain the engine in any gear.
- > Do not apply full throttle and avoid revving the engine beyond necessary levels.
- > Where possible, avoid fast acceleration and heavy braking. This does not apply in the event of emergencies.



NOTE: Fuel and engine oil consumption may be higher during running-in phase.



NOTE: Smoke may occur during the first drive because of wax and oil evaporating off the exhaust system. If this is to happen upon completion of the first drive, park the vehicle in an open outdoor space and avoid inhaling any fumes.

STARTING AND STOPPING THE ENGINE

Ignition Position



CAUTION: Do not hold the key in position (4), once the engine has started release the key immediately. Failure to do this may damage the vehicle components.

1. Insert the key into the ignition barrel, position (1)
2. Turn the key clockwise to switch on the accessories (ACC), position (2)
3. Turn the key clockwise again to switch on the ignition (IGN), position (3)
4. Turn the key clockwise again to start the engine, position (4)
5. After the engine has started, release the key to allow it to return to position (3).

VEHICLE OPERATION

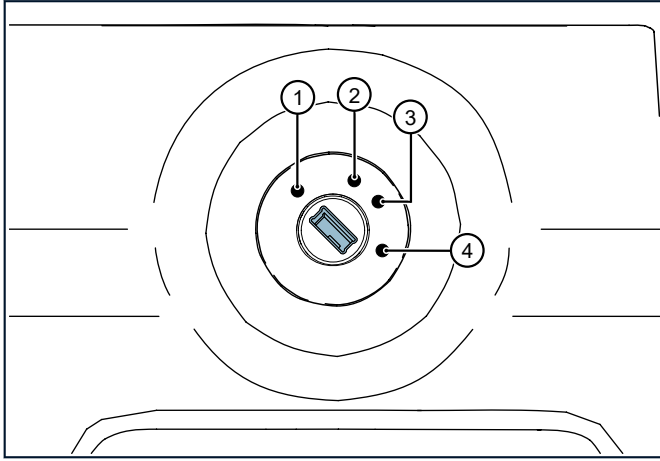

Starting the Engine



WARNING: The engine can be started by any person in the vehicle if the key is in the ignition. Care should be taken that the vehicle is not left unattended with the key present and occupants such as young children inside. The foot brake must be applied to start the engine. If the foot brake is not applied then the engine will not start.



WARNING: Make sure the handbrake is applied and the transmission is in park (P). This will prevent the vehicle from moving once the engine is started.



CAUTION: In extreme low temperatures (-20°C and below), do not run the engine above 4000 rpm, while at standstill or when moving off, until the coolant temperature gauge reaches normal operating temperature. If you do, there is a risk of damage to the engine.

Apply pressure to the brake pedal, turn the key to position (4) until engine starts. Once the engine has started, release the key. This will allow the key to rotate back to position (3).

Switching Off the Engine



WARNING: Make sure the handbrake is applied and the vehicle is in Park (P) before switching off the engine. This will prevent the vehicle from moving once the engine is started.

To switch off the engine, rotate the key to position 1 and remove the key.

Eco Start / Stop (ESS)

ESS temporarily switches off the engine when the vehicle is stationary, such as, stopped at traffic lights or in traffic.

VEHICLE OPERATION

Eco Start / Stop Operation (ESS)

The Eco Start / Stop function is on by default when the car is started. ESS can be manually switched off by pressing the  button (10), located on the centre console.

The engine will switch off automatically, if the vehicle is in gear **D** and the brake pedal is applied when the vehicle is stationary. When the engine has stopped and the brake pedal is applied, the gear can be changed to **P** and the brake pedal can be released, the engine will stay in a stopped condition.

The engine will automatically restart after shifting into **D** and/or the brake pedal is released. The engine will also restart when:

- > Driver opens the drivers door and releases the drivers seat belt (Auto P will be engaged).
- > Gear selector is in position **N, R or M** (Manual).
- > Driver applies the accelerator pedal .
- > Oil level measurement is started.
- > ESS button is pressed.
- > Air condition management is changed.
- > Vehicle rolling is detected.
- > Time limit of 3 minutes, is reached.

Eco start / stop will deactivate if any or multiple of the situations below apply:

- > Gear selector is in position **N, R or M** (Manual).
- > Vehicle battery state of charge is below 50%.
- > The vehicle is on a steep gradient.
- > Brake pedal is not adequately applied.
- > Drivers seat belt is not worn and drivers door is not properly closed.
- > Bonnet is not properly closed.
- > Engine, gearbox or battery is not up to optimal temperature.
- > The Two-Speed Transfer Case is in Low Range.
- > Off-road Mode or Wading Mode is active.
- > The outside temperature is too low or high.
- > A trailer is connected.

VEHICLE OPERATION

STEERING WHEEL CONTROLS

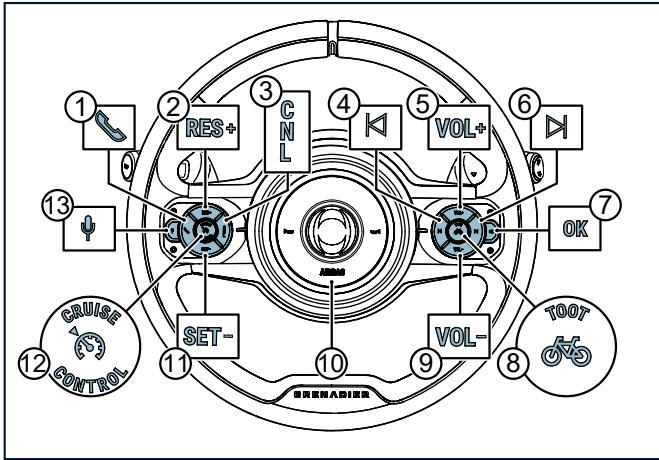

BUTTON	DEFINITION
1	Press to answer a phone call.
2	Resume speed or increase speed when using Cruise Control or Downhill Assist.
3	Cancel selection.
4	Skip to previous track or radio station. A long press will perform a track rewind or radio frequency change.

VEHICLE OPERATION

BUTTON	DEFINITION
5	Volume increase.
6	Skip to next track or radio station. A long press will perform a track fast forward or radio frequency change.
7	OK to select or confirm selection.
8	Warning tone for use around cyclists or pedestrians.
9	Volume decrease.
10	Main horn to warn others of the vehicle's approach or presence, or to call attention to a hazard.
11	Set speed or decrease speed when using Cruise Control or Downhill Assist.
12	Activates the Cruise Control into standby, ready to be set. Deactivates the Cruise Control.
13	Voice Recognition (Apple CarPlay® and Android Auto).

Horn and Toot Functions



WARNING: Do not use the toot function to alert other vehicles to your presence.

The horn , button (10) in the steering wheel controls above, is used to warn others of the vehicle's presence, or to call attention to a hazard.

The toot button  ¹⁰⁰⁷, button (8) in the steering wheel controls above, activates a warning tone that is quieter than the standard horn feature. The purpose of the toot, is to politely alert cyclists or walkers of your presence.

WINDOWS AND MIRRORS

VEHICLE OPERATION

Windows



WARNING: Window switches can be operated by all occupants. It is important that they are not misused in anyway. Drivers must advise all passengers, of the possible danger and make sure that all obstructions are clear before raising the window.



WARNING: It is important that when the windows are open, the occupants must keep their hands and arms inside the vehicle to avoid injury. It is also essential that items, such as, long objects or body limbs are not hanging out of the windows as this can cause serious injury or a crash.



WARNING: When transporting pets, it is important to check they can not reach the window opening and they are correctly restrained to avoid injury or an accident.



NOTE: It is recommended to apply a water repellent coating to the front door windows at regular intervals. This will help to clear water from the windows, improving driver vision.

The ignition must be set to on for the windows to operate. If the power is disrupted, such as, a battery disconnection or the ignition is turned off, then the windows will fail to operate as expected.



NOTE: The windows will continue to be powered up to sixty seconds after the ignition has been turned off.

The driver and the passenger windows in both the front and back seating area are electrically operated by buttons in the doors. The driver window control panel consists of four switches to allow the driver to operate all windows. The switch to operate the passenger windows is a single switch in each of the passenger doors.

Press on the window switch until the window moves, then let go and the window will continue to open. You can stop this with another press on the switch.

To close the window, pull the window switch and hold until the window is closed. There is no self run function when closing the window.





NOTE: No Anti-pinch function available.

Exterior Mirrors

The exterior mirrors are electrically adjustable using the mirror control pad located on the driver door. Press the mirror switch left or right to select the side to adjust. Move the directional pad up, down, left or right to adjust the selected mirror.

VEHICLE OPERATION

Folding Mirrors

-  **WARNING:** Take care folding and unfolding the mirrors. Folding the mirrors with force can damage the vehicle.
-  **WARNING:** Do not drive with the mirrors folded, this will reduce visibility around the vehicle and can lead to a crash.
-  **WARNING:** After unfolding the mirrors, adjust the mirrors, to ensure visibility is good before driving. Failure to do this may result in a crash.

The exterior mirrors can be folded manually, this should be done from outside of the vehicle.

Power Heated Exterior Mirrors (OPTIONAL)

The heated door mirrors will automatically switch on and operate, when the heated rear window button  is pressed.

The heating will switch off automatically after 30 minutes.

Interior Mirrors

The rear view mirror is attached to a ball mounting, this allowing the driver to adjust the position of the mirror.

The rear view mirror can be manually dimmed using the lever (1) positioned beneath the mirror. Push the lever towards the front of the vehicle for the mirror to appear dimmed, and returning to a

non-dimmed position, by pulling the lever towards the back of the vehicle.

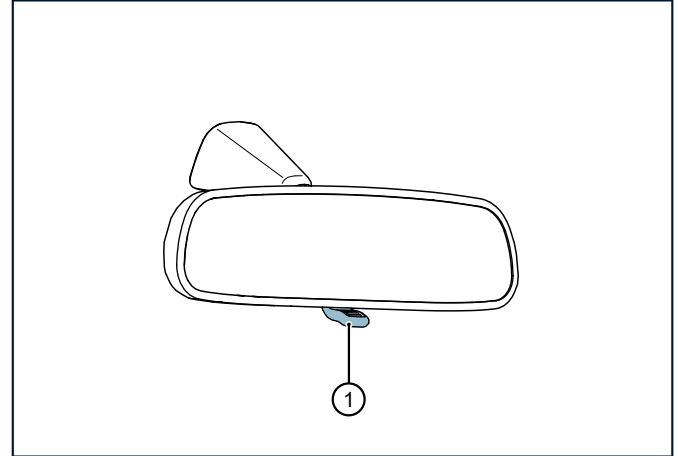



Safari Windows (OPTIONAL)

The safari windows are located in the roof of the vehicle. The safari windows can be partially opened to let air flow in and out of the vehicle in hot climates or when drying the interior after washing. The safari windows can be completely removed and stored in the vehicle.

VEHICLE OPERATION

 **WARNING:** Do not operate the safari windows while driving.

 **WARNING:** Make sure the mechanism is fully locked into place when the safari window is opened but not removed.

 **WARNING:** Do not drop the safari windows on to hard surfaces. Always handle with care.

 **WARNING:** Always firmly grip the safari windows and slowly guide the windows through the sunroof opening. Dropping or pulling the window through the opening quickly can result in damage to the vehicle or serious injury to the occupants.

 **CAUTION:** It is important to close the safari windows in bad weather conditions to avoid water damage to the interior of the vehicle.

 **CAUTION:** Never leave the safari windows partially open or fully removed when away from the vehicle.

To partially open the safari windows:

1. Push the latch mechanism towards the front of the vehicle.
2. Push the latch mechanism upwards, until the latch mechanism is firmly pushed and locked into place.

To completely remove the safari windows, follow this procedure:

1. Partially open the safari windows.
2. Push the lower section of the locking mechanism upwards. Do this until the safari window and the lower section of the locking mechanism detach.
3. Push the safari window upwards until it is possible to direct the safari windows away from the front of the vehicle, freeing the brackets from the latch support.
4. The safari window should be held with a firm grip using two hands to guide in through the opening.



NOTE: Do not balance the window on the vehicle roof, in the process of detaching.

Safari Window Storage



WARNING: The storage bag must be secured, to avoid moving around in the vehicle, causing injury to occupants or damaging the vehicle.



CAUTION: Use the storage bag when moving or transporting the safari windows. Failure to do so may result in damage to the vehicle and to the windows.



There is a dedicated storage bag, to safely store the safari windows after removal from the vehicle.

VEHICLE OPERATION

 **NOTE:** In the Station Wagon, the bag must be placed in the rear of the vehicle, strapped in using the lashing eyes to keep secure and in place.

 **NOTE:** In the Utility Wagon, it is recommended that the bag is stored in an upright position, behind the front passenger seat and secured into place for safety.

INTERIOR LAMPS

 **NOTE:** The interior lamp switch  is located on the roof console, The switch overrides the individual reading lamp switches and door ajar light switch.

Interior lamps include first row, second row reading lamps and foot-well lamps (if applicable).

A single press of the button will turn on the interior lamps. Press again to turn them off. When the interior lamps feature is switched on, a small LED lamp will illuminate on the button.

First Row Reading Lamps

The first row reading lamps are located in the overhead control panel, between the driver and front passenger.

The reading lamps are equipped with individual switches. Single press the switch, to turn on the respective side of the reading lamp, and single press the switch, to turn off the reading lamp.

 **NOTE:** If the following conditions are met, the reading lamps will remain illuminated even if the lamp switch position is off.

> Interior lamp switch is turned on.

> Courtesy lamp switch is set to auto and any door is open.

Second Row Reading Lamps

Each reading lamp is equipped with individual switching buttons, marked by a diamond texture.

Single press the switch, to turn on the respective side of the reading lamp and single press the switch to turn off the reading lamp.

The switch bezel swivels on the hinge, at middle of the bezel. Only one side of the lamp can be pressed at one time.

Ambient Lamps

LAMP	MOUNTING LOCATION	STANDARD / OPTIONAL
Overhead Console Lamp	Overhead Control Panel	Standard
Glovebox Lamp	Glovebox	Optional

VEHICLE OPERATION

LAMP	MOUNTING LOCATION	STANDARD / OPTIONAL
Foot-well Lamp	Under Instrument Panel	Optional
Ambient Door Lamp	Door Interior Trim	Optional

The overhead console lamp and the ambient door lamps (if applicable) will illuminate, in the following conditions:

- > Low beams are switched on
- > High beams are switched on
- > Headlamps are set to AUTO.

The glovebox lamp, will illuminate when opened, or deactivated when closed.

The foot-well lamps will illuminate, if the interior lamp button  is on, or if the courtesy lamp function is activated. The courtesy lamp function is activated, if the doors are opened, key is used to unlock the doors or the ignition is turned off.

Puddle Lamps (OPTIONAL)

The vehicle may have puddle lamps installed.

If a door is opened, then the respective puddle lamp will automatically switch on. If the door is closed, then door puddle lamp will switch off.

Puddle lamps will switch off after ten minutes, if a door is left open and the ignition is off.

Loadspace Lamps

The loadspace lamp is located in the headliner, at the back of the vehicle.

The rear loadspace lamp will illuminate, when the rear 30/70 doors are opened and off again, when the 30/70 doors are closed.

Courtesy Lamps



NOTE: Door ajar lamps (courtesy lamps) are independent of reading lamp switches and the interior lamp switch.



NOTE: Door ajar lamps are automatically on if the doors are opened, even though the reading lamp switches or the interior lamp switches are set to off.

Door ajar includes first row, second row reading lamps and foot-well lamps.

All lights are turned on / off simultaneously, however the function is automatic if the door ajar switch is set to on and a door is opened.

VEHICLE OPERATION

EXTERNAL LAMPS

All external lamps are sealed lamp units with light-emitting diode (LED) as the light source. The lamp units are not repairable. If a lamp or lamp unit fails, contact your INEOS approved partner.

Low Beam

The low beam is for use at night in areas illuminated by street lamps, such as towns and cities or when driving in low visibility weather conditions. The low beam uses an asymmetrical beam to illuminate a shorter distance of the road ahead compared to high beam to avoid the blinding of oncoming vehicles.

To switch on the low beam, rotate the end of the left lever stalk to position 3. To switch off the low beam, rotate the end of the lever stalk back to the 'OFF' position; Position 1.

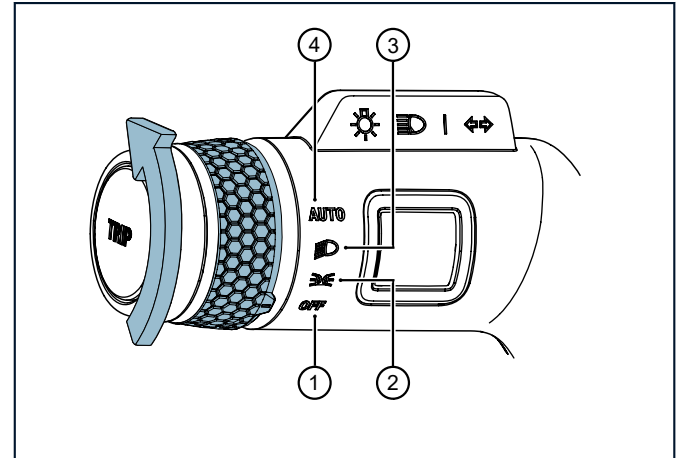

POSITION	STATUS	DEFINITION
1	OFF	Low beam lamp functions are switched off
2	Parking Lamps	Parking lamps are active.

VEHICLE OPERATION

POSITION	STATUS	DEFINITION
3	Low Beam	Low beam is activated
4	AUTO	Switches low beam on automatically when vehicle sensors pick up low enough ambient light to switch lamps on.

Parking Lamps



CAUTION: Leaving the parking lamps on while the engine is switched off, will drain the battery and should only be used for a limited period of time.

To switch on the parking lamps, rotate the end of the left lever stalk to position 2. It is recommended the parking lamps are used when parking on the side of the road at night or when visibility is first effected by the weather.

Auto Light Control

When the automatic light control function is switched on and the engine is running, the system switches between daytime running lamps and low beam headlamps automatically. This depends on the external lighting conditions and the information given by the sensor system. When entering and leaving a tunnel for example,

the low beam headlamps will automatically turn on when there is minimal day light. They will turn off again when leaving the tunnel and the sensors recognise good daylight.

To switch on the automatic light control function rotate the end of the left lever stalk to position 4.

The auto function switches between daytime running lamps to the following functions:

- > Lamps front and rear on.
- > Parking lamps front and rear on.
- > Low beams on.
- > License plate lamps on.

High Beam



WARNING: If switched on with nearby traffic or oncoming traffic, switch the high beam to low beam to avoid dazzling other drivers. There is a risk of an accident if the oncoming drivers are temporarily blinded.

The high beam is used to illuminate the road at night when there is no street lamps or if the vehicle is being used in a situation with no lighting such as driving off-road at night.

To switch on the high beam, push the left lever stalk away from the driver, towards the front of the vehicle. To switch off the high

VEHICLE OPERATION

beam pull the lever stalk towards the driver back into the starting position.

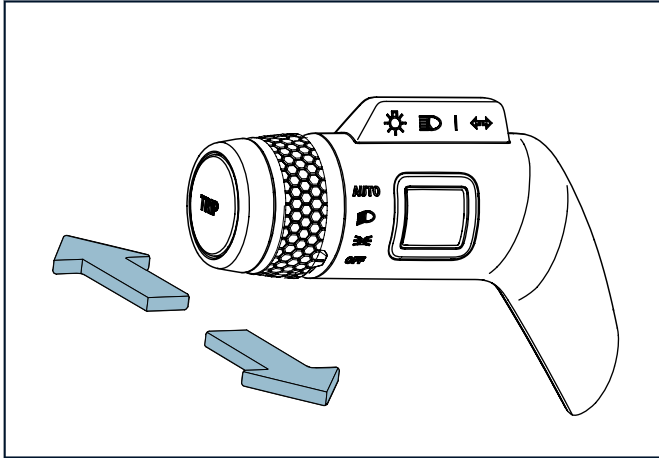

High Beam Flash

To flash the headlight pull the left lever stalk towards the driver to activate the headlight and then release back to the starting position to deactivate the headlight. This will result in the headlight flashing on and off once. Repeat for consecutive flashes of the headlights.

Daytime Running Lamps

Daytime running lamps, increase visibility of the vehicle during daylight. They are switched on automatically during the daytime, when the engine is running. The system can switch between daytime running lamps and headlamps automatically, depending on the lighting conditions.

Direction Indicators

To briefly indicate, push the left lever stalk upwards or downwards and release. To indicate continuously push the left lever stalk upwards or downwards, until the left lever stalk latches into

VEHICLE OPERATION

position, giving an indication signal. To cancel, move the lever stalk back to the starting position.

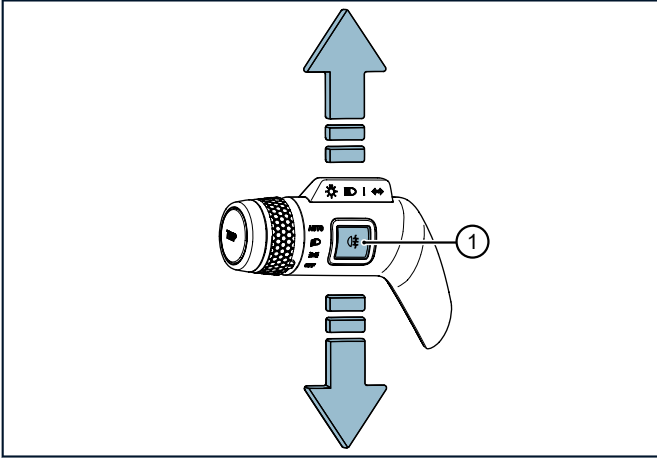

Rear Fog Lamps



WARNING: Remember to switch off the rear fog lamp when the function is not necessary as this can blind or distract other drivers.

The rear fog lamps  are operated by pressing button (1) on the stalk.

The rear fog lamp is for use in fog or other adverse weather conditions with low visibility.

HAZARD LAMPS



NOTE: When the ignition is switched off, the hazard warning lamps will continue to operate.

Press the hazard warning lamp button (13), located on the centre console, to activate the hazard warning lamps.

VEHICLE OPERATION

When the hazard warning lamps are switched on, all direction indicator signals will flash. Press the button (13) again, to switch the hazard warning lamps off.

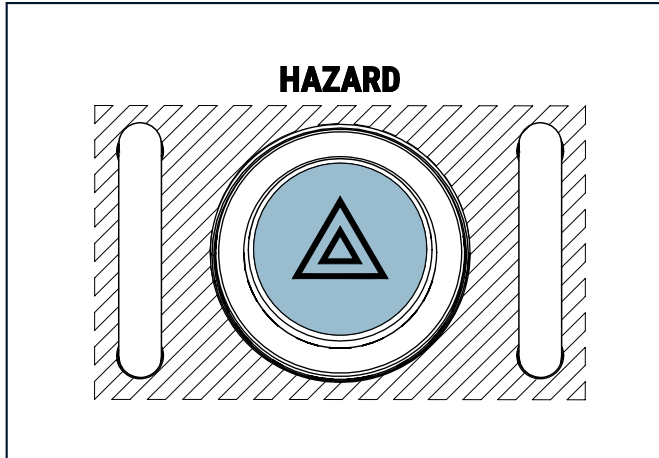



Reverse Lamps

When the ignition is set to on and the reverse gear is selected, the reverse lamps will illuminate.

LED Auxiliary High Beam Lights

The LED Auxiliary High Beam Lights, also known as the working lamps, are additional headlamps that can only be activated together with the high beam (In some regions Off-road or Wading Mode must also be selected). To operate the lamps, the ignition first needs to be on and the  button located in the overhead control panel should be then pressed, which will illuminate to notify the driver that the lamps are switched on.

-  **NOTE:** The lamps will have the same effects as the high beam which will create glare to oncoming traffic.
-  **NOTE:** The use of the LED Auxiliary High Beam Lights are strictly for off-road purposes only. LED Auxiliary High Beam Lights could temporarily blind other road users.

Headlamp Range Adjustment

-  **WARNING:** It is important to adjust the headlamp range, dependent on the weight distribution within the vehicle. Failure to adjust the headlamp range, may temporarily blind other road users.

The distribution of the weight in the vehicle, effects the height of the headlamp beams. Always adjust the headlamps to maintain adequate illumination of the road and space in front of the vehicle, without dazzling other drivers and road users. Turn the

VEHICLE OPERATION

thumb wheel  located in the roof console, to the required switch position.

POSITION	LOAD
0	Driver only, or driver and all front seats occupied (load-space empty)
1	All seats occupied (load-space empty)
2	All seats occupied by adults (load-space at maximum)
3	Driver only (load-space at maximum)

Driving Abroad

The tourist mode is achieved through the use of tape that is attached to the outer lens to partially block the low beam.



NOTE: INEOS recommends the following:

- > 3M™ Temflex™ 1500
- > Scotch® Vinyl Electrical Tape 22
- > Comparable PVC based electrical / insulating tape with natural rubber adhesive.

Make sure the tape dimensions are 55 mm width x 35 mm height. The tape needs to be applied to the upper low beam lens.



The following image, shows how the low beam light pattern should look on a 10 meter wall.

VEHICLE OPERATION

Without Sticker:

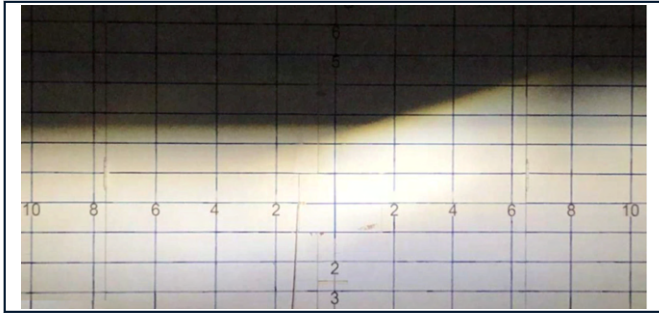

With Sticker:

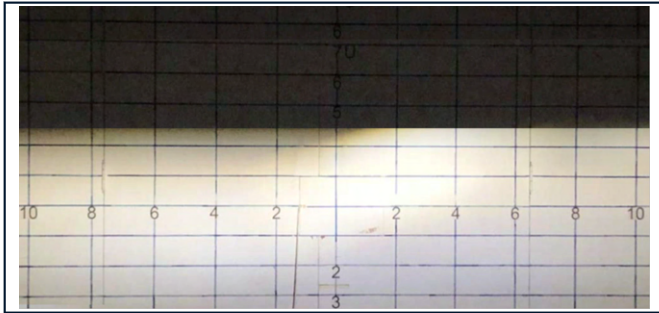

WIPER AND WASHER SYSTEM

The wiper and washer system is a system that keeps the view clear by removing raindrops on the windscreen glass and the back window glass when it rains. When used with the washer system, dirt and dust can be cleared from the windscreen glass. For these reasons, this is an essential system for driving vehicles safely.

VEHICLE OPERATION

The front wipers are controlled by pushing the stalk up or down.

Windscreen Wiper

The right stalk controls the vehicle wipers, wash and wipe function.

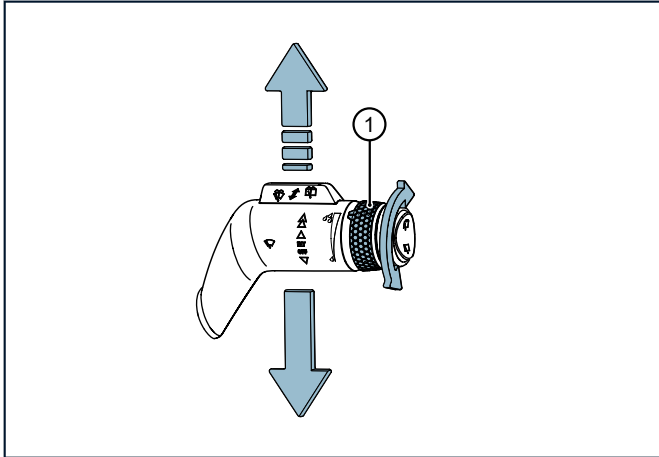

SPEED	DEFINITION
OFF	This is the bottom resting position for the selector. The front wipers should be off.

VEHICLE OPERATION

SPEED	DEFINITION
QUICK WIPE	From the off position, when the stalk is temporarily pushed down, the wipers will perform a single sweep. The stalk will return to the off position as soon as it is released.
INTERMITTENT	Pushing the stalk up, one click, will turn on the wipers to sweep intermittently. The speed is controlled by the rotary selector (1). Twisting this away from the driver increases the wiper speed. Twisting towards the driver will decrease the wiper speed.
LOW SPEED	Push the stalk upwards twice from the off position. This will put the wipers on a low speed, continuous sweep.
HIGH SPEED	Pushing the stalk up, one click from low Speed, two from intermittent and three from off, puts the wipers on a high speed, continuous sweep.

Push the stalk back down, to the desired setting or off position, from a higher position.



CAUTION: Set the ignition to on and the wipers to off when in a car wash or if the vehicle is being pressure washed. Ignition on will make sure the wiper arms are locked into the park position and will help prevent damage to the wiper arms.

VEHICLE OPERATION

Rear Window Wiper

The rear wiper is controlled with a three-position toggle button, on the end of the stalk.

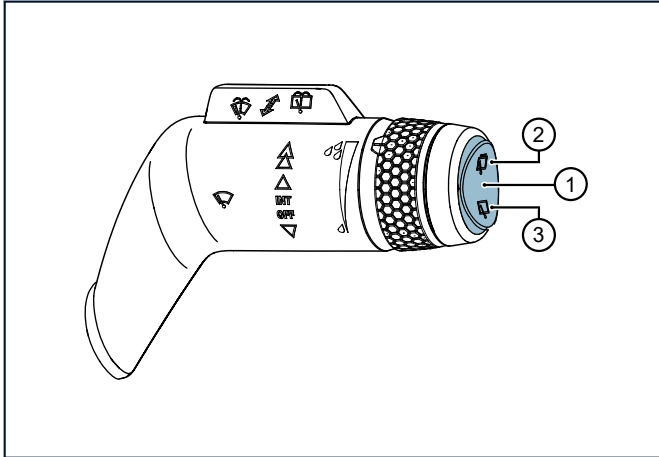

BUTTON	SPEED DESCRIPTION
1	OFF - The top and bottom of the switch should sit proud of the Stalk end. The rear wiper is off.

VEHICLE OPERATION

BUTTON	SPEED DESCRIPTION
2	INTERMITTENT - Push the top of the button so that it sits flush with the end of the stalk, the wiper will sweep intermittently.
3	CONTINUOUS - Push the bottom of the button so that it sits flush with the end of the stalk, the wiper will sweep continuously.

VEHICLE OPERATION

Windscreen Washers

The wash and wipe is controlled by pushing the Stalk away from, or pulling towards, the driver.

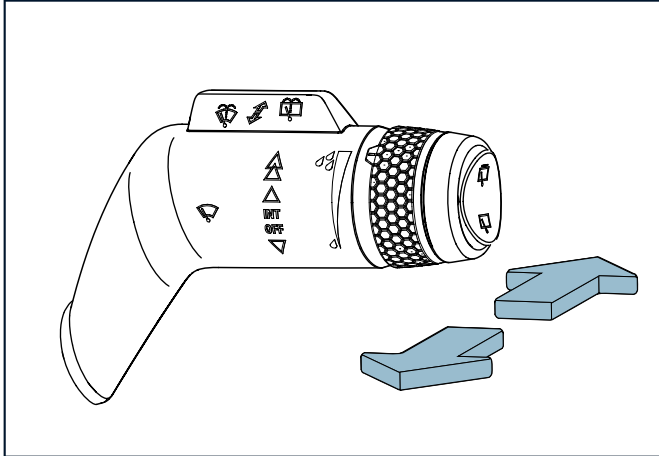

Pushing the stalk away from the driver temporarily, will activate the rear washer and the wiper will perform a continuous sweep for a set amount of time. Pulling the Stalk towards the driver temporarily will activate the front washers and the wipers will perform a low speed sweep for a set amount of time.

The stalk will return to the resting position as soon as it is released.

Heated Windscreen Washer Jets (OPTIONAL)

The washer nozzles are heated automatically in cold weather to prevent the washer fluid from freezing. They can also be manually activated with the heated rear window button .

HANDBRAKE



WARNING: When parking the vehicle, the brake pedal must be fully applied and it is essential that the gearbox is placed in the parking position (P). Then the handbrake should be applied to hold the vehicle in position. Do not leave the vehicle on a slope without completing these two steps. Not following this instruction may result in injury or death.



CAUTION: Do not apply the handbrake until the vehicle has stopped completely. Applying the handbrake lever while the vehicle is moving will lock the rear brakes and can make the vehicle unstable or result in the malfunction of the handbrake.



CAUTION: While driving, the hand brake lever must be fully released, otherwise the brakes may overheat resulting in damage to the vehicle.

VEHICLE OPERATION

To release:

1. Firmly press and hold the brake pedal.
2. Pull the handbrake lever slightly up.
3. Press the button at the end of the handbrake grip.
4. Lower the hand brake lever completely.

To apply:

1. Bring the vehicle to a complete stop before applying the handbrake.
2. Firmly press and hold the brake pedal.
3. Pull the hand brake lever as far as possible without pressing the button at the end of the handbrake grip.

Pull the handbrake lever sufficiently to hold the vehicle stationary at a complete stop after releasing the brake pedal. Depending on the gradient and payload, the handbrake lever must be pulled further and the gearbox needs to be placed in the parking position (P). If the handbrake does not hold the vehicle stationary after the brake pedal is released, then the vehicle must be checked by an INEOS approved partner.

DRIVETRAIN

The drivetrain transfers power generated by the engine to the wheels. Thus, providing the torque for your vehicle to move forward or in reverse.

Automatic Transmission

The Grenadier's transmission combines the functions of an automatic transmission with the possibility of manual shifting.

The vehicle uses an eight - speed automatic gearbox and a two-speed transfer case. Using a two-speed transfer case allows for eighteen gears: sixteen forward and two reverse. The two-speed transfer case also has a centre differential, which distributes the drive to both the front and rear axles, providing permanent four-wheel drive.

Gear Selector Positions

The gear selector is used to switch between the transmission modes.

The gear selector engages one of the following:

VEHICLE OPERATION

SYMBOL	GEAR	DEFINITION
P	Park	The transmission is locked into a parked position and unable to move or roll. Only select park P when the vehicle is not moving or rolling.
R	Reverse	Only select reverse R when the vehicle is stationary.
N	Neutral	The vehicle may be pushed to roll without power.
D	Drive	All gears for forward travel are selected automatically.

Park is engaged automatically when:

- > The driver seat belt is unbuckled.
- > The drivers door is not shut correctly.
- > The engine is switched off and the transmission is still in drive or reverse.

Gear Selection



WARNING: Maintain pressure on the brake pedal to prevent the vehicle from moving, after you select a gear position.

VEHICLE OPERATION

To operate the gear selector, follow this process:

1. Make sure the driver seat belt is fastened.
2. Press and hold the button to release the selector lever lock.

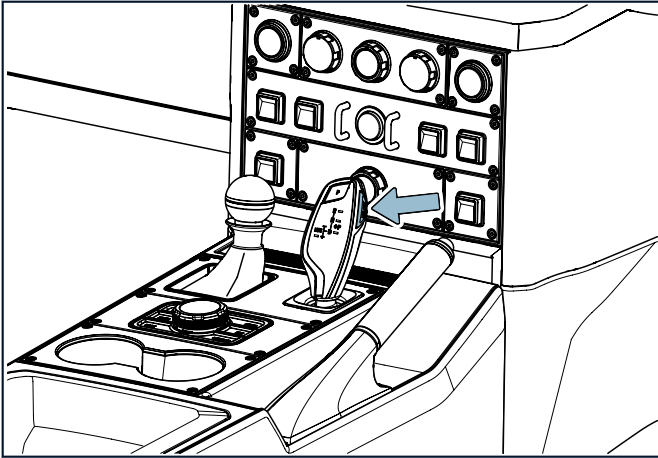

3. Push the selector lever in the desired direction. The selector lever automatically returns to the center position when released.

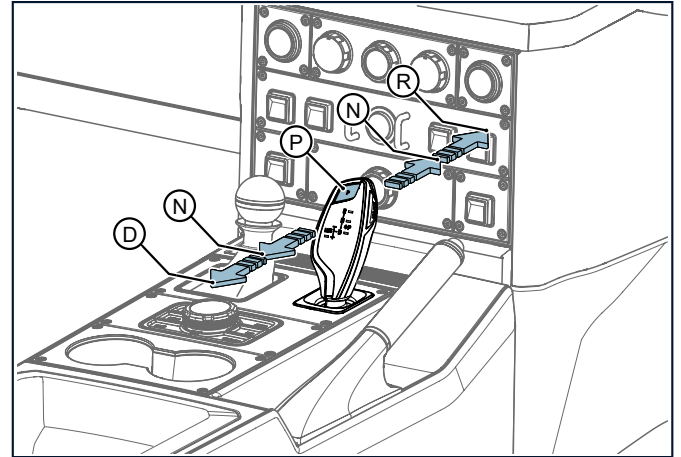

NOTE: Engage reverse, only when the vehicle is stationary.

VEHICLE OPERATION

Car Wash Function

The process below puts the vehicle into a state for safe rolling.

1. Put the transmission into **N** while pushing the brake pedal.
2. Stop the engine.
3. Immediately turn on the ignition without starting the engine.
4. Now "car wash function" is engaged and the vehicle can be pushed.



NOTE: If the ignition is not switched on the Park position will be engaged after several minutes.

If there is a malfunction, you may not be able to change the gears. If this happens call the nearest INEOS approved partner for support.

Activating Manual (Mode) and Shifting



WARNING: Do not allow the engine to rev too high or on the rev limiter, for a period of time. If the vehicle revs on the limiter for a period of time, then you risk overheating and potential component failure. This will result in the need for recovery to an INEOS approved partner.

The 8 - speed gearbox is automatic, but the driver can switch to manual mode. It may be necessary to switch to manual mode when driving down a steep hill.

To activate manual mode, please follow the procedure below:

1. Push the gear lever to the left from gear lever position **D**.

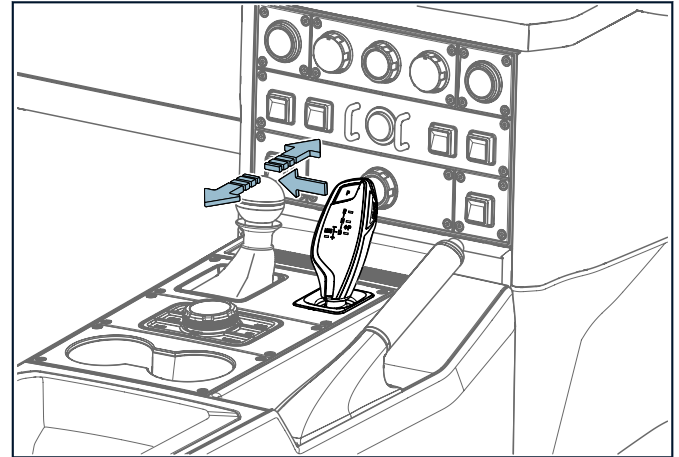

2. Use the gear selector to manually change gears:
 - > To shift down, press the gear selector forward.
 - > To shift up, pull the gear selector rearwards.

VEHICLE OPERATION

 **NOTE:** The transmission will shift automatically in certain situations. For example, when the Revolutions Per Minute (RPM) threshold is reached.

To exit manual mode, push the gear selector back to position **D**.

Gear Shift Indicator

The gear shift indicator is designed to help reduce fuel consumption by recommending the most suitable gear.

Depending on the driving situation and the vehicle's equipment, the system may recommend skipping one or more gears. The condition of the road, the traffic density and safety should remain determining factors when choosing the best gear. Therefore, the driver remains responsible for selecting the correct gear for a given situation.

 **NOTE:** The system cannot be deactivated while in manual operation mode.

The information is shown on the infotainment screen in the form of an arrow and the recommended gear. This is located next to the fuel level gauge.

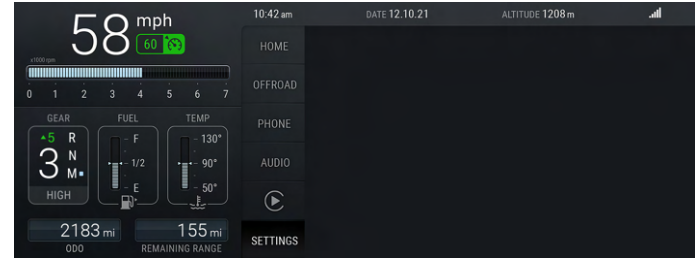

 **NOTE:** The system adapts the gear change instructions according to the driving conditions. For example, slope or load and driving style, such as, power demand, acceleration and braking.

Two-Speed Transfer Case

The two-speed transfer case is designed to aid the driver when off-road driving or towing. The two-speed transfer case receives power from the transmission and sends it to both the front and rear axles. The positions are 'High', 'High lock', 'Low' or 'Low Lock'.

Engaging Transfer Case Selector Positions



WARNING: Low range should be used for off-roading or when wading. The low range gears should not be used on public roads.

VEHICLE OPERATION

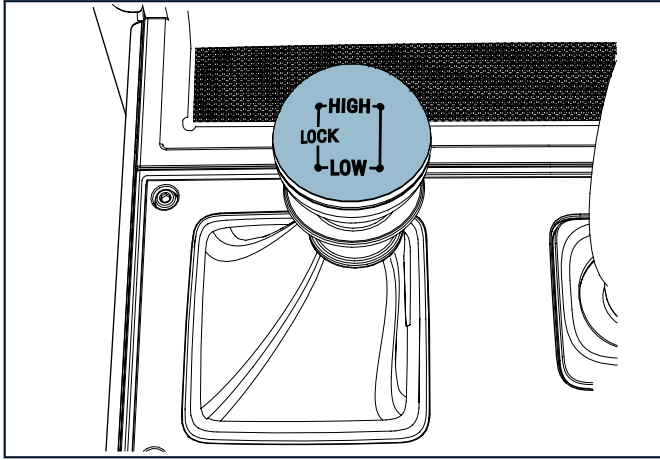

The two-speed transfer case selector has a locking ring that must be pulled upwards before a different position can be selected.

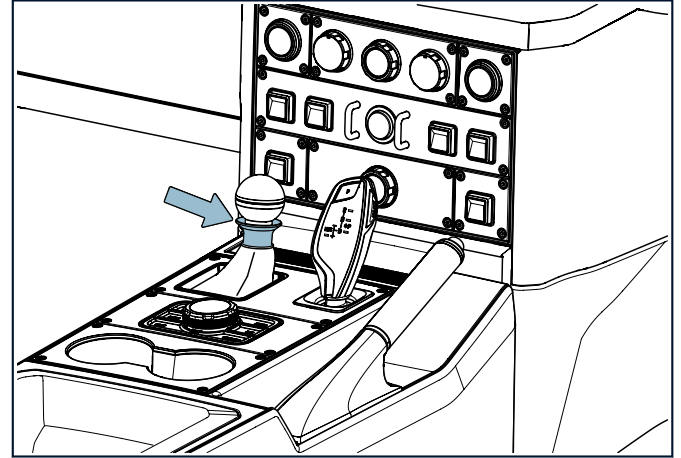

The two-speed transfer case selector engages the following:

HIGH - High range is used for all normal road driving and for off-road driving across dry, level terrain.

LOW - Low range should be used for pulling off from a stopped position with a heavy load, manoeuvring at low speeds with a

VEHICLE OPERATION

trailer or driving over challenging terrain at low speeds. Do not use 'LOW' on public roads.

To switch between the 'HIGH' and 'LOW', the vehicle needs to be stationary and the transmission must be in **N**.

 **WARNING:** Maintain pressure on the brake pedal, to prevent the vehicle from moving after you select a gear position.

 **WARNING:** Do not screw the 'neutral screw' on the transfer box anti-clockwise, unless the vehicle is already in a neutral state and you are putting the vehicle back into a drive state. If the screw is rotated the wrong way or removed, then this WILL result in severe damage to the two-speed transfer case.

 **CAUTION:** Do not use pneumatic tools or electric tools on the 'neutral screw'. The 'neutral screw' must be rotated carefully.

 **CAUTION:** This is an emergency neutral, for recovery and towing purposes only.

The two-speed transfer case can be put into neutral, in order to tow or roll the vehicle. First, the vehicle must be secured with chocks, this will stop the vehicle rolling. Secondly, from underneath the vehicle, located on the transfer box, is the 'neutral screw'. The screw must be rotated clock-wise, screwing inwards until it can't go any further. Once the screw has been screwed in, as far as possible, the vehicle will be in a neutral state.

The 'neutral screw' can be identified by the word 'NEUTRAL' and a directional arrow, both visible on the casing. This will confirm the clockwise rotation, to achieve the neutral status of the vehicle.

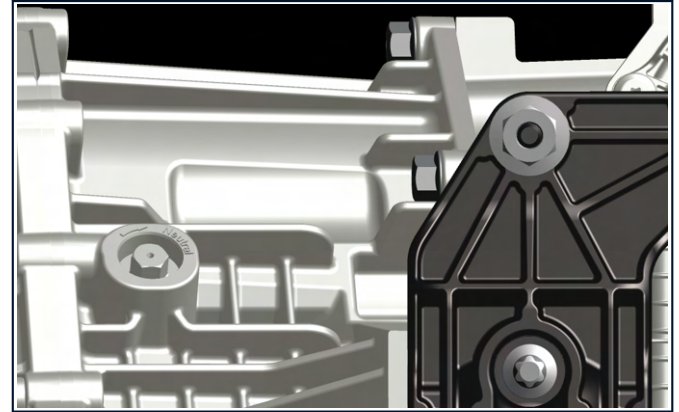



 **NOTE:** Try to engage 'HIGH' or 'LOW', to be certain that the neutral status of the vehicle has been achieved.

 **WARNING:** When removing the vehicle from neutral after towing or rolling, it is important that the screw is rotated anti-clockwise, but only until the screw head is flat and flush with the transfer box casing. Any more than this will result in severe damage to the two-speed transfer case.

VEHICLE OPERATION

Differentials

 **WARNING:** Inappropriate operation and usage of the differential can be dangerous. This can result in component failure and damage to the vehicle, even injury or death, if a major component fails.

 **WARNING:** Locked differentials can cause instability on high traction surfaces. This can cause an incident where the vehicle is damaged or injury is sustained.

 **WARNING:** Never lock the front differential on a descent. Vehicle handling can be significantly reduced. It is dangerous and can lead to an accident or injury.

 **WARNING:** It is possible to drive the vehicle up to 43 mph (70 km/h) while the differentials are engaged. Caution must be exercised as stability functions are NOT functional with the differentials engaged. Failure to take caution can result in damage to the vehicle, injury or even death.

 **CAUTION:** Acute turning angles can strain the drive line on high traction surfaces. This will put stress on components and may result in damage to the vehicle.

 **CAUTION:** Only use the differential lock on low traction surfaces such as snow, sand or mud.

 **CAUTION:** If the vehicle is driven on normal road surfaces with a differential locked, the steering will feel stiff, the tyres wear excessively and transmission 'wind up' will occur. This puts the transmission under excessive strain and can cause premature failure, which may not be covered by warranty.

 **CAUTION:** The differential locks must be engaged before the obstacle and disengaged immediately after overcoming the obstacle. Long-term use may lead to thermal overload and permanent damage to the system.

 **NOTE:** *It is recommended, that only trained or competent drivers should use the differential locks.*

Permanent 4x4

Permanent 4x4 is a system that powers all four wheels at all times and it can be used full time on all surfaces including pavement. The additional feature of a differential incorporated into the transfer case makes it possible to use 4WD all the time. Each tyre creates about 25% of the available torque, when the ground is level with a uniform surface. Full time 4WD vehicles work very well on-road and are very capable off-road.

Centre Differential Lock

 **CAUTION:** The differential should only be locked when operating the vehicle on low traction surfaces. Locking

VEHICLE OPERATION

the differential on high traction surfaces can strain the drive line components.



WARNING: None of the differentials should be locked on high traction surfaces. A locked differential will severely impact the driving dynamics on high traction surfaces, making the vehicle unstable and dangerous to drive. This could result in an accident, serious injury or loss of life.

The vehicle is fitted with a lockable centre differential, which is selected by the transfer case selector. When the differential is unlocked it allows the two axles to run at difference speeds to meet the requirements of each axle.

With an open center differential, if a single wheel on either the front or rear axle loses traction, the ability for any of the wheels on the vehicle to transfer drive to the road surface, will be severely reduced or lost completely.

Locking the center differential will distribute torque evenly to the front and rear axle at all times, meaning if a single wheel loses traction, it will only limit the ability of the respective axle to transfer drive to the road. The other vehicle axle will not be affected. On low traction surfaces, locking the center differential can often improve the vehicle's ability to transfer drive to the surface and improve the overall vehicle traction.

Lockable Rear and Front Differentials (OPTIONAL)



WARNING: When the front differential is locked, the steering possibilities of the vehicle are heavily limited.

The driver can lock the rear and front differentials from inside the cabin.

When a differential is locked, both wheels on the affected axle will rotate at the same speed for improved traction on difficult driving surfaces.



NOTE: When the rear and/or front differentials are locked, the Electronic Stability Control and Anti-locking Brake System are automatically disabled.

How to Lock the Rear and Front Differentials



WARNING: Do not engage the rear and front differential locks, if one or more wheels are spinning, as this can damage the transmission.





CAUTION: The differentials must only be locked when driving off-road on loose and slippery surfaces. Always unlock the differentials for normal road driving or as soon as a non-slippery surface is reached, even if low gears are selected on the transfer case. If you do not, the steering will feel stiff, the tyres will wear excessively and transmission wind-up will occur, which can cause damage to the transmission.



CAUTION: If the differential lock tell-tale is illuminated orange then this means the differentials are engaged. If the tell-tale is blinking on and off orange, then this means the differentials are engaging. If there is an error,

VEHICLE OPERATION

then the tell-tale will illuminate red. If the tell-tale is illuminated red consult with your INEOS approved partner.

The rear and front differentials, are locked and unlocked, with two buttons in the overhead control panel. Both, the rear  and front  differential buttons, have a small LED which will illuminate, when the differentials are engaged.



Differential Lock Sequence:

1. Transfer Case in 'LOW LOCK' Position.
2. Rear Differential Lock.
3. Front Differential Lock.

To lock the rear differential, press and hold the rear differential lock button for one second while following the listed conditions:

- > Engine running.
- > Transfer Case in 'LOW LOCK' position.

- > Speed below 9 mph (15 km/h).
- > Accelerator pedal application below 40%.
- > No spinning wheels.
- > The Electronic Stability Control system must not be actively supporting the driver, when switching on the differentials.





NOTE: If the vehicle is stationary and you press the rear differential lock button for one second, the LED on the rear differential lock button will flash. As you start to move the vehicle, the differential lock status will be visible on the tell-tale cluster.

To lock the front differential, press and hold the front differential lock button for one second while following the listed conditions:

- > Engine running.
- > Transfer Case in 'LOW LOCK' position.
- > Speed below 9 mph (15 km/h).
- > Rear differential lock engaged.
- > No spinning wheels.
- > The Electronic Stability Control system must not be actively supporting the driver, when switching on the differentials.

VEHICLE OPERATION

 *NOTE: If the front differential lock button is pressed before the rear differential lock has been engaged, then the button LED will flash once and the front differential lock will not engage.*

 *NOTE: If the vehicle is stationary and the rear differential lock has already been engaged. You can press the front differential lock button for one second, the LED on the front differential lock button will flash. As you start to move the vehicle, the differential lock status will be visible on the tell-tale cluster.*

To unlock the front or rear differential a short button press is needed. This can be done in any driving condition.

If you disengage the rear differential lock before you disengage the front differential lock, then both the front and rear differentials will be disengaged.

 *NOTE: If you disengage the center differential lock before you disengage the rear and front differential lock, then all three differentials will be disengaged.*

When unlocking the front and rear differential locks the vehicle operates a state check. The check may take some time as it depends on the current vehicle movement to detect the correct state. Driving at low speeds while steering the vehicle left and then to the right, may reduce the state detection time.

VEHICLE LOADING



WARNING: If loading large items or heavy items, take care and do this with the help of multiple people. It is also advised that the appropriate loading equipment is used where possible to avoid injury or death.



WARNING: Loading the vehicle with heavy items can change the handling characteristics of the vehicle. Take care when driving with a heavy load.



WARNING: Ensure that loads are secured into place when transporting heavy loads. It is dangerous to drive the vehicle with heavy loads moving around while in transit.

Exterior Utility Belt (OPTIONAL)



WARNING: The Exterior Utility Belt (and any items attached to it) can only be used when off-road. On-road use is prohibited. Loading equipment on the exterior of the vehicle may change the handling characteristics. Users should not load the vehicle, any options or accessories (or any part of them) beyond their intended capacities. Improper use of the vehicle or other equipment may be unsafe and could result in property damage and/or injury to users and/or other parties.

VEHICLE OPERATION

The Exterior Utility Belt is positioned on the vehicle doors and under the third row window / panel. It is supplied with four Quick Release Tie-Down Rings, which slot into the pre-defined locations along the belt.

LOAD PER HOOK			
UPPER UTILITY RAIL		LOWER UTILITY HOOKS	
Front Door	10 kg	Front Door	5 kg
Rear Door	15 kg	Rear Door	10 kg
Rear Quarter Panel	15 kg	N/A	N/A

TOTAL LOAD PER RAIL / TETHERING HOOK (DOOR)			
UPPER UTILITY RAIL		LOWER UTILITY HOOKS	
Front Door	45 kg	Front Door	15 kg
Rear Door	35 kg	Rear Door	20 kg
Rear Quarter Panel	40 kg	N/A	N/A

Interior Utility Rails (OPTIONAL)



WARNING: Ensure equipment in the load space is secure, users should not load the vehicle, any options or accessories (or any part of them) beyond their intended capacities. Improper use of the vehicle or other equipment may be unsafe and could result in property damage and/or injury to users and/or other parties.

The Interior Utility Rails are located on the loadspace floor. They are supplied with four Quick Release Tie-Down Rings which slot into the pre-defined locations along the rail.

Roof Loading



WARNING: Be aware of load height on the vehicle (including any roof racks) when using tunnels or locations with height restrictions such as car parks with entrance height restrictions.



WARNING: If loading large items or heavy items, take care and do this with the help of multiple people. It is also advised that the appropriate loading equipment is used where possible to avoid injury or death.



CAUTION: Only INEOS original Roof Rack / Roof Bars are allowed to fix on drain gutter. Pay load must allocate equally and pay load center of gravity should be as low as possible.

VEHICLE OPERATION



CAUTION: Maximum roof load capacity (with Roof-Rack accessory) is 420 kg static and 150 kg while driving (dynamic). Do not exceed the roof load capacity limit.

When loading the roof of the vehicle it is important to obey any applicable laws or regulations related to driving with a roof load.

INEOS recommends the heaviest items are loaded into the rear of the vehicle and the lighter items are loaded onto the roof.

Always inspect the roof load and any roof racks before use. It is important to follow the manufacturers instructions for maintenance to ensure a safe and secure roof load.

When loading the roof, think about the positioning of items before securing in place. The shape, weight and size of the items loaded onto the roof can change the handling characteristics of the vehicle. Plan in advance how everything will be tied down and positioned. Long items such as canoes or surf boards may have some over hang. Remember that this can not only alter the height of the vehicle, but the length too.

Access Ladder (OPTIONAL)



WARNING: Maximum load capacity on the Access Ladder is 150 kg.



WARNING: The Access Ladder can only be used when the 30/70 split doors are completely closed. Use of the ladder with the 30/70 split doors open, can result in injury or damage to the vehicle.

The Access Ladder is at the rear of the vehicle.

DRIVING WITH A ROOF LOAD



WARNING: Avoid sudden steering movements as this can make the load unstable, or even cause the vehicle to over turn causing serious injury or death.



WARNING: Avoid traversing side slopes which can tip the vehicle.



WARNING: Make sure to adjust the pressure of the vehicle tyres to drive with the added weight of the roof load.

If travelling for a long duration, then it is essential to take regular stops or comfort breaks to walk around the vehicle, checking the roof load for security. Any securing equipment such as ties or straps should be checked to make sure nothing has moved or become unstable. Failure to do so could result in injury or death if items were to move or fall from the vehicle.

When operating the vehicle with a roof load, the weight of the vehicle is increased. This means it will take longer to slow down or stop when braking. It is advised to drive at a slower speed with the extra weight carried. Be vigilant and sensible.

VEHICLE OPERATION

FUELLING



WARNING: Before fuelling, switch off ignition and never allow sparks or flames near the fuelling tank filler valve. Follow the operating and safety instructions of the filling station when fueling.



WARNING: Do not allow naked flames near fuel.



WARNING: Do not smoke near fuel.



WARNING: Fuel and fuel vapor is explosive. Do not create sparks if you are near fuel or if you can smell fuel in and around the vehicle. If you can smell fuel in your vehicle, have this investigated immediately by an INEOS approved partner or notify your emergency services.



WARNING: The fuel system may be under pressure. If you hear a hissing sound near the fuel filler inlet, do not refuel until the sound stops. Otherwise, fuel may leak out, which could cause serious personal injury.



WARNING: Do not overfill the fuel tank. The pressure in an overfilled tank may cause leakage and lead to a fuel leak and risk of fire.



NOTE: Do not fill the fuel tank in the event of parking on a slope, such as, a steep driveway or on a hill. The fuel

can escape through the overflow and be spilt onto the driveway or road.

Fuel pumps have an automatic cut off when the tank is full. Do not continue fueling past a full tank as this will lead to spillage from the overflow. It is critical that you follow the health and safety rules of the filling station. It is recommended not to do the following, in a filling station:

- > Smoke.
- > Use mobile phone.
- > Create a spark.
- > Use a naked flame.



NOTE: It is recommended, that you wear protective gloves when filling with fuel at a fuel station.

Fuel Level and Remaining Range Warnings

The remaining fuel range and the current fuel level, can be seen by looking at the infotainment screen.

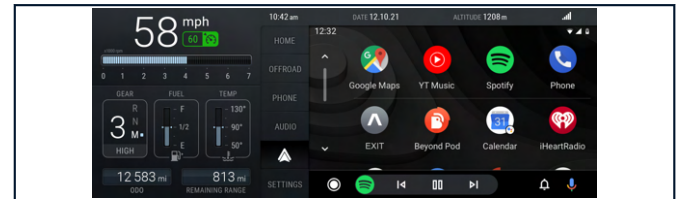

VEHICLE OPERATION

There are three stages of fuel level warning:

1. The fuel level gauge and the remaining range will change colour from white to amber, when the remaining fuel is between 74 miles (120km) and 43 miles (70 km). This is a warning that the fuel is getting low, and that the vehicle will need to be refuelled soon.



2. Secondly, the remaining range will be replaced with a message, notifying the driver that they should refuel soon.



3. The third warning changes the fuel level gauge and the remaining range from amber to red when the remaining range is less than 43 miles (70 km). This is a warning that

the vehicle is using reserve fuel, and must be refuelled as soon as possible.



Opening Fuel Flap

The fuel flap is located at the rear, right side of the vehicle.

The vehicle must be unlocked to open the fuel flap. To open the fuel flap, push the rear edge of the fuel flap inwards and release. The fuel flap will pop open.

To close the fuel flap, push the rear edge, until the fuel flap is securely closed.

Opening Fuel Cap

Turn the cap slowly anti-clockwise to open. Once the cap is loose, hook it onto the inside of the fuel flap.

VEHICLE OPERATION

AdBlue (Diesel Engine Only)



WARNING: Do not fill the AdBlue with the engine running.



WARNING: AdBlue is non-toxic but can cause irritation to the skin and eyes.



CAUTION: Immediately wash any AdBlue from the body work of the vehicle. AdBlue can damage vehicle paint if left on vehicle body.



CAUTION: Do not put AdBlue into the diesel tank as this will cause damage to the fuel tank, pump, and injection system. If there is AdBlue inside the diesel tank, do not turn on the ignition or start the engine and call your nearest INEOS approved partner.

AdBlue is a colourless, non-toxic mixture of urea and de-ionised water. Tiny amounts of AdBlue are injected into the flow of exhaust gases. At high temperatures AdBlue turns to ammonia and carbon dioxide.

Harmful nitrogen oxide in the exhaust reacts with the ammonia inside the Selective Catalytic Reduction (SCR) catalyst, and is transformed into harmless nitrogen and water.

AdBlue Levels



NOTE: INEOS recommends that the engine is switched off, when filling up the AdBlue.

The AdBlue tank capacity is approximately 17 litres. To check the level of AdBlue, navigate to the settings on the infotainment screen. Select vehicle Functions, vehicle information and then AdBlue. The AdBlue level will be shown as a percentage and the quantity required to top up until full.

If the level of AdBlue falls below 25%, then the colour of the percentage will change to amber, indicating the AdBlue will need topping up soon. If the tank level falls to 10% or below, then the percentage level will change to red to indicate the AdBlue tank should be filled as soon as possible.

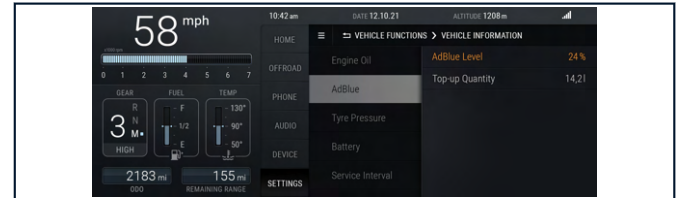

An AdBlue Reserve warning will be activated, when the remaining distance reaches 1,490 miles (2,400 km).

VEHICLE OPERATION

AdBlue reserve
AdBlue level low- Please refill AdBlue

An AdBlue warning will be visible when the remaining distance is 248 miles (400 km) or less. The remaining distance will be visible on the infotainment screen between 248 miles (400 km) and 0 miles (0 km).

AdBlue - No restart in 400 km
No restart in 400 km- Please refill AdBlue

When the **AdBlue** distance remaining reaches 0 miles (0 km), the warning message below will be visible:

No start- fill AdBlue
AdBlue empty- Please refill AdBlue or engine will not start



NOTE: If the level of AdBlue in the tank is completely depleted, then the engine will not start. If this happens, refill the AdBlue immediately. Once refilled, make sure the ignition and engine are switched off so when you

restart the vehicle, the warning will be extinguished. It is advised to wait a short period of time before restarting the vehicle.

AdBlue Filler Location

AdBlue is an exhaust fluid, not a fuel additive. It is stored in a separate reservoir and is topped up through the AdBlue filler cap, located next to the fuel filler cap.



NOTE: Only use a car nozzle when filling the vehicle with adblue.

PARTICULATE FILTERS

Diesel Particulate Filter (DPF)

The DPF forms part of the emissions reduction systems fitted to your vehicle. The DPF is designed to filter harmful diesel gases and particulates, such as, soot from exiting the vehicle into the atmosphere.

Regeneration



WARNING: Do not leave your vehicle parked or idling over dried grass or leaves and any other combustible materials. The DPF regeneration process causes the exhaust to be extremely hot, which will radiate heat for

VEHICLE OPERATION

some time after the regeneration process has been completed. Allow the vehicle to cool down where there are no combustible materials and where there is good air ventilation.



CAUTION: Make sure there is enough fuel in the vehicle to complete the full regeneration process. Failure to do this will result in the vehicle running out of fuel, which can cause potential damage to the vehicle.

Unlike a normal filter, which requires periodic replacement, the DPF has been designed to regenerate, or clean itself to maintain operating efficiency. The filter is cleaned periodically by burning off the soot particles within the DPF at high temperatures.

If the vehicle is being driven short distances or even long distances with frequent acceleration and deceleration or stopping and starting then this can lead to a build up of soot inside the DPF. To prolong the life of the DPF and to assist with the regeneration process:

- > Preferably drive on a motorway or dual carriageway where the vehicle can be driven at a constant speed with minimal risk, while observing the road conditions and speed limits.
- > Avoid prolonged idling and stop/start driving.
- > Do not switch off the ignition part way through the journey.

- > The journey should be a minimum of 20 minutes to allow the engine and DPF to reach normal operating temperature.
- > Where appropriate and safe, use a lower gear than normal to maintain higher engine speed above 2000 rpm, also keeping the temperature high in the DPF.



NOTE: Fuel consumption may be higher during this period. The emission smoke and the smell of burning during this process is normal, the DPF is regenerating and burning the contents inside.



NOTE: Upon completion of the journey, there might be a clicking metallic sound or hot metallic odour from the vehicle. This is normal due to the high temperatures sustained through the regeneration process. If the regeneration process is not possible, or there is an issue

with the DPF, the engine light  will illuminate.



CAUTION: For any suspected issues with the DPF system, contact your nearest INEOS approved partner for advice. Do not ignore or drive long distances with a fault, until the DPF system has been serviced or replaced.

Gasoline Particulate Filter (GPF)

The GPF system, is designed to reduce harmful gases and particulate emissions emitting from the vehicle, through the exhaust system. Particulates over time will be burnt away at high

VEHICLE OPERATION

temperatures, this is known as regeneration and happens automatically when driving the vehicle.

Regeneration

Unlike a normal filter, which requires periodic replacement or regeneration, the GPF has been designed to operate at high temperatures to keep the GPF system from becoming blocked. The GPF will gather and burn harmful particulates while you are driving to avoid any harmful particulates being emitted by the exhaust system and entering the atmosphere.

If the vehicle is being driven on regular short distance trips, it is recommended that you take the vehicle for an occasional drive on a motorway or dual carriageway, observing the road conditions and speed limits, allowing the engine and GPF to heat up to a high temperature to burn any particulates gathered.



NOTE: Avoid prolonged idling and stop / start driving, as this can lead to a build up of particulates inside the GPF.



WARNING: For any suspected issues with the GPF system, contact your nearest INEOS approved partner for advice. Do not ignore or drive long distances, until the GPF system has been serviced or replaced.

Catalytic Converter

The catalytic converter is designed to reduce the amount of harmful substances released into the atmosphere with the exhaust gases.

DRIVER SUPPORT AND FEATURES

OFF-ROAD DRIVING	101
CRUISE CONTROL	104
EMERGENCY STOP SIGNAL (ESS)	107
ELECTRONIC STABILITY CONTROL (ESC)	107
ANTI-LOCK BRAKE SYSTEM (ABS)	110
DOWNHILL ASSIST	110
UPHILL ASSIST	111
PARKING AID SYSTEMS	111
REAR-VIEW CAMERA (OPTIONAL)	115
SOS EMERGENCY CALL (eCall)	116
ROADSIDE EMERGENCIES	117
VEHICLE RECOVERY	120
TOWING A TRAILER	125

DRIVER SUPPORT AND FEATURES

OFF-ROAD DRIVING

The Grenadier is a capable off-road vehicle, but driving off-road can be dangerous. If possible, seek specialist advice and training.

 **WARNING:** Do not take any unnecessary risks and be prepared for emergencies at all times.

 **WARNING:** Be sure the driver has the relevant knowledge of off-road driving techniques in order to minimise any risks to you, the driver, passengers and the vehicle.

 **WARNING:** Always use your seat belt, when driving in all off-road driving modes, to ensure personal safety.

 **CAUTION:** Make sure the vehicle has enough fuel before off-road driving. If the fuel level is low then uneven ground and steep inclines could cause damage to the engine.

 **CAUTION:** Do not drive off-road with roof loaded. It is recommended, any luggage on the roof is removed before off-road driving. Especially before traversing side slopes.

The off-roading and wading control buttons are located within the roof console.



NOTE: Off-road Mode and Wading Mode should not be used on public roads.

Off-road Mode



WARNING: When the ESC OFF tell-tale is illuminated, caution should be exercised due to reduced stability functionality.

Off-road Mode, can be activated by pressing the Off-road Mode button  , located on the roof console.

To activate Off-road Mode, the vehicle must be stationary with the engine running and the handbrake on. The button has to be pressed for approximately one second, upon releasing the button, there is a fifteen second window to confirm activation of the Off-road Mode. To confirm, press the Off-road Mode button again and there will be an acoustic signal to confirm the activation has been completed. Once the activation has been confirmed there will be two tell-tale lamps illuminated, one being the Off-road Mode lamp



and the other will be the ESC Off lamp



. Furthermore, the infotainment unit will display a message, confirming the Off-road Mode activation and the button itself will illuminate a small LED.

To turn off the Off-road Mode, hold the Off-road Mode button  for at least one second and then release it. The button LED and the two tell-tale lamps will switch off, this will indicate that the Off-road Mode has been deactivated.

DRIVER SUPPORT AND FEATURES

When Off-road Mode is switched on, the Electronic Stability Control system becomes ESC Off-road. With ESC off-road mode engaged, the ESC functionality is reduced. Caution should be exercised.



NOTE: Off-road Mode will automatically deactivate, if the vehicle travels faster than 44 mph (70 km/h) or if the engine is turned off, for longer than thirty seconds.

CHANGES WHEN ACTIVATING OFF-ROAD MODE		
DEACTIVATED	ACTIVATED	CHANGED
Emergency Signal System (ESS)	Thermal mode	Electronic stability control (ESC)
Park Distance Control (PDC) Automatic		
Acoustic driver door status warning		
Roadside-to-vehicle communications (RVC)		
Acoustic seat belt reminder		

Wading Mode



WARNING: Keep the doors closed at all times when wading. Failure to do this can lead to interior flooding of the vehicle. This will damage the vehicle and risk injury to the occupants or even death.



CAUTION: The maximum wading depth is 800 mm. Wading in water deeper than 800 mm may damage the vehicle.



CAUTION: Never exceed 3 mph (5 km/h) during wading. If the maximum wading speed is not adhered to, then a wave might be generated that could enter the air intakes, causing irreversible engine damage (hydro lock).



CAUTION: Maximum continuous wading duration is 20 minutes. You should not wade continuously for more than 20 minutes. Wading for longer than 20 minutes may damage the vehicle and even result in the vehicle needing recovery.





CAUTION: Let the vehicle idle for a minimum of 20 minutes or drive the vehicle for 20 minutes straight after wading. Failure to do this can damage the starter motor.



CAUTION: Do not switch off the engine during wading, this may cause major damage to the powertrain.

DRIVER SUPPORT AND FEATURES

 *NOTE: The approach and departure angle is 16° (30%) for wading only.*

 *NOTE: In order to activate Wading Mode, the Off-road Mode should be activated. The transfer case should be in 'LOW' and the centre differential lock should be engaged.*

Wading Mode can be activated by pressing the Wading Mode button  located on the roof console. Press the button for approximately one second, upon releasing the button, there is a fifteen second window to confirm activation. To confirm, press and hold the Wading Mode button until an acoustic signal is heard. Once the activation has been confirmed the Off-road Mode

lamp  and the ESC OFF lamp  will be illuminated. The infotainment screen will display a message to confirm that the Wading Mode has been activated and the LED on the button will be illuminated.

To turn off the Wading Mode, press and hold the Wading Mode button  for at least one second. The button LED and two tell-tale lamps will switch off, this will indicate that the Wading Mode has been deactivated.

Alternatively, Wading Mode will automatically deactivate in the following circumstances:

- > Off-road Mode has been deactivated
- > Centre differential has been disengaged

> Transfer case has been changed from 'LOW' to 'HIGH'.

CHANGES WHEN ACTIVATING WADING MODE		
DEACTIVATED	ACTIVATED	CHANGED
DPF / GPF regeneration	Air circulation mode	Electronic stability control (ESC)
Side engine fans	Speed limiter 18 mph (30 km/h)	
Seat heating (if applicable)		
PDC Automatic		
Acoustic driver door status warning		
RVC automatic (still configurable by driver)		
Acoustic seat belt reminder		
Selective Catalytic Reduction (SCR) heating		

DRIVER SUPPORT AND FEATURES

CHANGES WHEN ACTIVATING WADING MODE		
DEACTIVATED	ACTIVATED	CHANGED
Particulate Matter (PM) / Nitrogen Oxides (NOX) Sensors		

Off-Road and Wading Mode Malfunction

If there is a malfunction, there will be no acoustic signal or indicator, when trying to switch modes.

In the case of a malfunction, It is recommended that the vehicle is not taken off-road as the vehicle will not have full capability to handle off-road surfaces and uneven ground. Under no circumstance should the vehicle be taken wading if there is a malfunction as this can damage the vehicle.

Raised Air Intake (OPTIONAL)

Raising the position of the engine air intake ensures the engine is fed with cleaner and cooler air in dusty environments.



NOTE: The Raised Air Intake does not improve wading performance or maximum wading depth.

Raised Air intake Cyclone Pre-Cleaner (ACCESSORY)



CAUTION: Only use the Raised Air intake Cyclone Pre-Cleaner when driving off road.

This attachment uses cyclone technology to spin the air at high speed before it enters the raised air intake air duct. This provides a centrifugal effect to any dust and dirt, preventing contaminants from entering the engine air intake. Recommended for very dusty and dirty environments.

CRUISE CONTROL



WARNING: Driver assistance systems are not designed to allow the driver a pause in concentration or to replace the drivers attention under any circumstance. The driver accepts full responsibility when driving the vehicle.



WARNING: Cruise Control is a driving aid to give comfort to the driver when driving for prolonged periods of time at a particular speed. It is essential the driver keeps concentration, only using Cruise Control when road and traffic conditions are suitable. Failure to do so, may cause an accident or collision resulting in death or serious injury.



WARNING: Cruise Control is developed as an aid only and can't take into account the road or weather

DRIVER SUPPORT AND FEATURES

conditions as they change. You as a driver are responsible for the vehicle speed set, applying the brakes smoothly and in good time, controlling the distance between you and any vehicle(s) nearby.



WARNING: Cruise Control is used to set a particular speed by the driver only, the driver is always responsible for keeping the vehicle under control inside the lane being used. Failure to keep the vehicle in the lane due to a lapse in concentration, can cause an accident or collision resulting in death or serious injury.

The Cruise Control system should not be used when:

- > road and traffic conditions do not allow you to maintain a constant speed, e.g. in heavy traffic or on winding roads.
- > driving on rough terrain or surfaces that might be slippery. For example, ice, gravel, sand or water.
- > driving in any conditions likely to cause the vehicle to skid, slide or lose traction when braking or accelerating.
- > visibility is poor in severe weather conditions, such as heavy rain, fog, or snow.

Activating Cruise Control

The Cruise Control is activated using the buttons on the steering wheel.

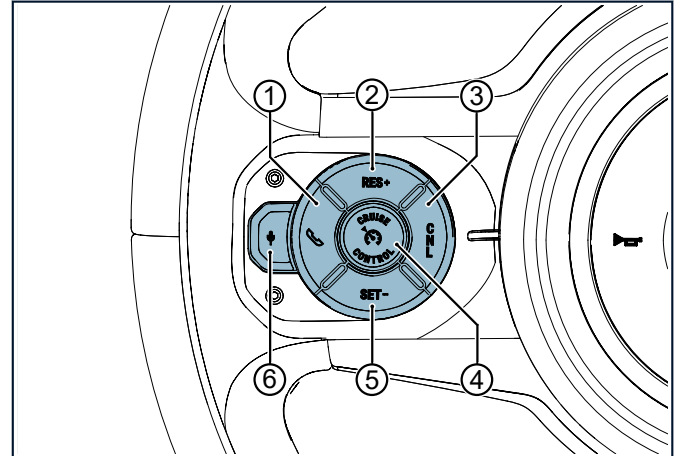

Press the Cruise Control button  (4), to activate the Cruise Control feature, in a standby state. This will be indicated on the

DRIVER SUPPORT AND FEATURES

infotainment screen by the grey Cruise Control symbol next to the speed value.

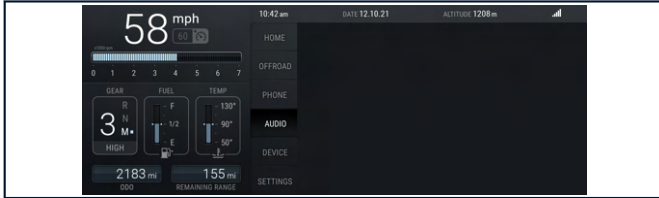

Adjusting Speed

i *NOTE: Cruise Control will only operate at speeds above 19 mph (30 km/h).*

Press the 'Set -' button (5), to set the Cruise Control to the current speed. Once active, the symbol will turn green and show the current set Cruise Control speed.

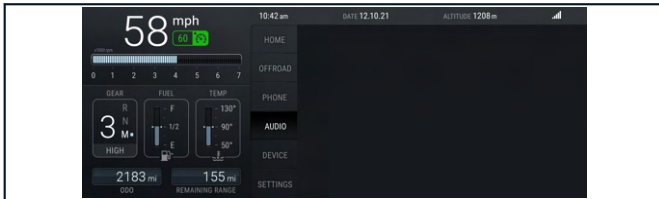

The set speed will be displayed in green, if the set speed is the same as that selected by the driver. If the speed is above or below the set speed, then the number will be displayed in grey not green.

Once the speed has been set it can be increased or decreased by pressing the 'RES +' button (2) or the 'SET -' button (5). A short press on either button will increase or decrease the speed. If the button is held, the speed will increase / decrease in greater increments.

i *NOTE: Cruise Control will automatically disengage when the brake pedal is pressed or when the vehicle speed falls below 19 mph (30 km/h).*

Resume Set Speed

! **WARNING: Set speed should only be resumed if it is safe to do so and the driver is aware of the set speed and intends to return to it. The driver must be aware of the traffic and weather conditions before resuming the last set speed.**

If at any point the driver presses the "CNL" button (3) the Cruise Control feature will go into standby mode. The same is true if the brake pedal is pressed or the Electronic Stability Control (ESC) activates. The last set speed will be saved and the Cruise Control symbol will be greyed out, including the speed number.

DRIVER SUPPORT AND FEATURES

Pressing the “RES +” button (2) will reactivate the Cruise Control to the speed last set. If the “SET -” button (5) is pressed, then the saved speed is overwritten by the current speed.

Deactivating Cruise Control

The “CNL” button (3) puts the Cruise Control back into standby. The same is true if the brake pedal is pressed or the Electronic Stability Control (ESC) activates. Once the Cruise Control is in standby mode, press the Cruise Control button  (4) once to deactivate Cruise Control.

EMERGENCY STOP SIGNAL (ESS)

If you brake heavily, the ESS function is triggered. The brake lamps will flash automatically when braking heavily and the hazard lamps will automatically activate once the vehicle has come to a stop.

ELECTRONIC STABILITY CONTROL (ESC)



WARNING: The electronic stability control system is a driving aid, the driver must keep concentration and pay attention to the traffic around them. The driver must be

ready to react to any change in the surrounding traffic, weather conditions, surface changes or obstacles in the way of vehicle travel.



WARNING: Do not deactivate the electronic stability control when driving with the roof loaded. The center of gravity is higher when driving with a roof load creating a much higher risk of tipping or an accident. This is particularly important in the event of sudden reactions such as avoiding obstacles in the road.



WARNING: When the rear and/or front differentials are locked, there is no stability support available to aid the driver. Drive the vehicle with extreme caution!



When ESC is actively supporting the driver, the ESC tell-tale lamp  will blink.



ESC aids the driver by supporting the stability of the vehicle using engine and braking interventions. Switching off the ESC reduces the stability control functions available to the driver.

ESC may support the driver differently depending on the vehicle state. See in the following tables, how ESC aids the driver depending on the vehicle state and whether or not the ESC OFF button is pressed.



DRIVER SUPPORT AND FEATURES

VEHICLE STATE	ESC OFF (Button Not Pressed)	ESC OFF (Button Pressed)
High / Low Gear (Centre Differential Not Locked)	Default Mode	ESC OFF Mode (Reduced Stability) > Display Text: ESC OFF > Tell-Tale:  OFF

VEHICLE STATE	ESC OFF (Button Not Pressed)	ESC OFF (Button Pressed)
High / Low Gear (Centre Differential Locked)	ESC in Off-road Mode > Display Text: ESC Off-road > Tell-Tale:  OFF	ESC OFF Mode (Reduced Stability) > Display Text: ESC OFF > Tell-Tale:  OFF



VEHICLE STATE	ESC OFF (Button Not Pressed)	ESC OFF (Button Pressed)
Off-road / Wading Active	ESC in Off-road Mode > Display Text: ESC Off-road > Tell-Tale:  OFF	ESC OFF Mode (Reduced Stability) > Display Text: ESC OFF > Tell-Tale:  OFF

DRIVER SUPPORT AND FEATURES

VEHICLE STATE	ESC OFF (Button Not Pressed)	ESC OFF (Button Pressed)
	ESC and ABS OFF (No stability support available)	
Rear / Front Differential Locked	<ul style="list-style-type: none"> > Display Text: ESC and ABS OFF > Tell-Tale:   	ESC OFF not available



- > Trailer Stability Assist function only active in Default Mode.
- > Downhill Assist is not available in ESC Off Mode.
- > Downhill Assist is not available when the rear and/or front differentials are locked.
- > Uphill Assist is not available when the rear and/or front differentials are locked.

ESC OFF Mode



-  **WARNING: When ESC is deactivated, the vehicles driving stability will be reduced when accelerating or cornering. Caution must be exercised!**
-  **WARNING: If the ESC symbol  stays illuminated, the ESC system has detected a fault. No stability support**

available when there is a fault. Consult immediately with your nearest INEOS approved partner.

It is not possible to deactivate ESC, while ESC is actively supporting the driver.

To deactivate ESC, hold down the ESC OFF button  located in the roof console. Hold the button until the tell-tale lamp  is illuminated and the infotainment screen displays ESC OFF.

When the vehicle is being driven in ESC OFF mode, the max speed before automatically reverting back to off-road mode or default mode is 48 mph (78 km/h).

To re-activate ESC, press and hold the ESC button  until the ESC OFF tell tale lamp  is extinguished.

DRIVER SUPPORT AND FEATURES

ANTI-LOCK BRAKE SYSTEM (ABS)

 **WARNING:** If the ABS lamp  is illuminated and the rear and/or front differentials are unlocked, then this means there is a fault. Consult immediately with an INEOS approved partner.

The anti-lock braking system (ABS) is designed to aid the driver during braking to improve the vehicle stability. ABS will activate to avoid the wheels locking up if the car loses traction.

DOWNHILL ASSIST

 **WARNING:** Downhill Assist is a driving aid. The driver must always be in control of the vehicle.

 **WARNING:** The driver must be ready to react to any change in the surrounding traffic, weather conditions, surface changes or obstacles in the way of vehicle travel.

Downhill Assist aids the driver by controlling the vehicle speed when going down hill. The driver is not required to use the brake pedal when using this feature.

Downhill Assist controls the speed of the vehicle to help keep the vehicle stable aiding the driver. The system will apply the brakes to individual wheels, keeping the vehicle stable moving down hill.

Activating Downhill Assist

Downhill Assist can only be activated, if the rear and/or front differentials are not engaged. In addition, the vehicle must not be travelling forwards above 15 mph (25 km/h), or reversing above 6 mph (10 km/h).

Press the Downhill Assist button  located in the overhead control panel to activate Downhill Assist.

Once activated, the infotainment screen will display the Downhill Assist symbol in green.



The same symbol will blink when Downhill Assist is in control.



NOTE: Downhill Assist will not be available when ESC OFF has been pressed or when the rear and/or front differentials are engaged.

DRIVER SUPPORT AND FEATURES

Adjusting Speed

 **NOTE:** Downhill Assist will only operate at speeds less than 15 mph (25 km/h) or reversing at speeds below 6 mph (10 km/h)

The Downhill Assist speed can be increased or decreased by pressing the “RES +” button (2) or the “SET -” button (5), located on the steering wheel.

Deactivating Downhill Assist

Press the Downhill Assist button  once to deactivate Downhill Assist. Downhill Assist will automatically disengage if the driver accelerates above 15 mph (25 km/h), or 6 mph (10 km/h) in reverse.

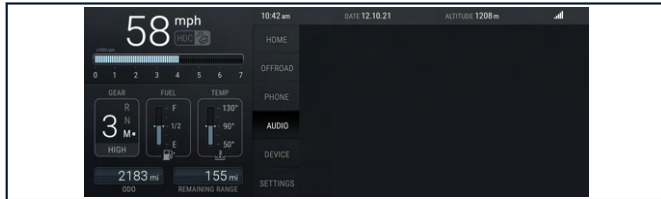

 **NOTE:** If ESC OFF is pressed, then downhill Assist is automatically deactivated.

 **NOTE:** When activating the rear and/or front differential lock, Downhill Assist will automatically deactivate.

UPHILL ASSIST

 **WARNING:** If the rear and/or front differential is locked, then Uphill Assist will not be available.

Uphill Assist is a driving aid designed to hold the vehicle for a short time only in the event of a hill start. It is the driver's responsibility to ensure that the vehicle does not roll back even when the feature is active.

The appropriate gear must be selected depending on the direction of travel in order for the feature to become active. Uphill assist is not available when neutral is selected.

PARKING AID SYSTEMS

 **WARNING:** The parking aid systems are for aid only. It is the driver's responsibility to be aware of their surroundings when parking or reversing.

 **NOTE:** When the tow bar socket is used for tow bar mounted items, such as an accessory bike rack or trailer, the rear parking sensors and Active Park Assist systems will be deactivated.

DRIVER SUPPORT AND FEATURES

i *NOTE: The Bull/Roo Bar accessory and/or third-party Bull/Roo Bars may interfere with the front parking sensors. Consult your nearest INEOS approved partner when installing any Bull/Roo Bar accessory.*

Park Distance Control

! **CAUTION:** It is always the driver's responsibility to detect obstacles and estimate the vehicle's distance from them. Some overhanging objects, barriers, thin obstructions or painted surfaces which could possibly cause damage to the vehicle may not be detected by the system. Always be aware of your surroundings when using the parking aid systems.

! **CAUTION:** Do not clean the sensors with abrasive or sharp objects. This could result in damage to the sensors.

i *NOTE: For reliable operation, the sensors in the front and the rear bumpers should be kept free from ice, frost and dirt. If a high pressure spray is used to clean the vehicle, the sensors should only be sprayed briefly and from a distance greater than 20 cm.*

The Park Distance Control (PDC) system uses four sensors at the rear of the vehicle and optionally, four more sensors at the front of the vehicle.

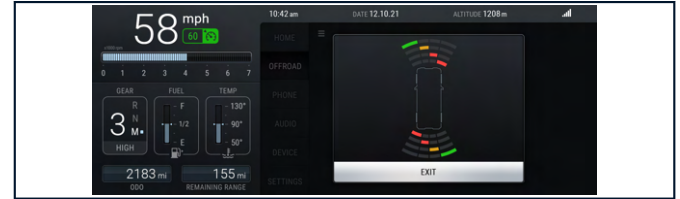

Park Assist Rear, provides audible and visual warnings on the infotainment screen when you are travelling at low speeds and come close to an object or other vehicles.

Park Assist Front (if applicable), provides audible and visual warnings on the infotainment screen when you are travelling at low speeds and come close to an object or other vehicles.

Parking Sensor Activation

The PDC system, is automatically activated when the reverse gear is engaged.

An engaged reverse gear **R**, shall only prompt an activation of the Park Assist Rear, if the current driving mode is set to 'Normal Mode'. The automatic activation will not occur when in 'Off-Road Mode' and 'Wading Mode'.

DRIVER SUPPORT AND FEATURES

i *NOTE: The system will not function if the handbrake is applied. If the handbrake is applied and reverse is selected, the reverse camera works but a message is displayed on the infotainment screen. The PDC rear will be off and the switch on the centre control unit panel will also be inactive.*

Parking Sensor Deactivation

The system can be deactivated, manually by pressing the  button (8), located in the bottom right corner of the centre console, or automatically when the park gear **P** is engaged or the handbrake is applied. The PDC will automatically deactivate, if the vehicle speed surpasses a defined threshold of 10 mph (15 km/h), or a continuously covered distance of 50 m (164 ft) forward.

If the vehicle is in 'Off-road Mode' or 'Wading Mode', the PDC will automatically deactivate.

Park Assist Front (if applicable), can be switched off manually in the settings menu. This will be visible on the infotainment screen to confirm.



Park Assist Rear, will automatically switch off if there is a trailer attached. This will be visible on the infotainment screen.

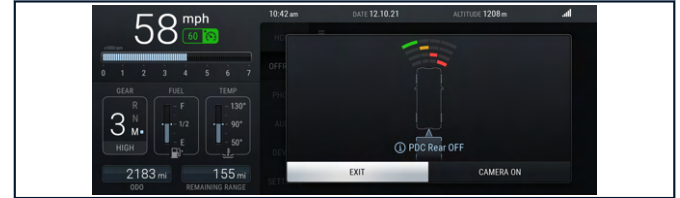

When the Park Assist Rear is switched off then the screen below will be visible.

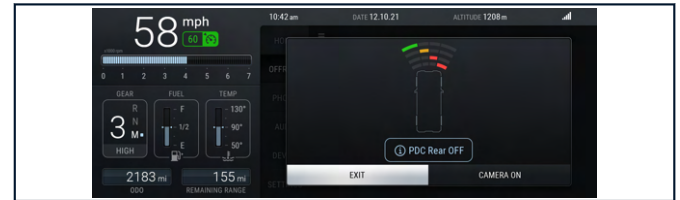

Parking Sensor Operation



CAUTION: In heavy rain or similar adverse conditions, the PDC sensors may not always be able to accurately measure distance to close objects. A fully laden vehicle

DRIVER SUPPORT AND FEATURES

or irregular obstacles may also cause inaccurate measurements. Take extra care in these circumstances.

If an obstacle is detected at the front or rear of the vehicle, a series of warning tones will be heard. The frequency of the warning tones increase as the vehicle approaches the obstacle.

The beep becomes a continuous tone when an obstacle is detected at or within approximately 0.4 m (1.3 ft) of the vehicle.

i *NOTE: If an ultrasonic frequency using the same frequency band as the sensors is detected, the PDC system can give spurious warning tones.*

i *NOTE: The PDC system uses inner and outer sensors. When maneuvering forward into a garage, the front outer sensors will cease detection if they detect a stationary or receding object for three seconds or more. This allows detection directly in front or behind the vehicle in this type of manoeuvre.*

i *NOTE: If there is a fault, then a warning message will be displayed on the infotainment screen.*

Parking Distance Control Malfunction

i *NOTE: If there is a fault, then a warning message will be displayed on the infotainment screen.*

If there is a fault with the Park Assist Front (if applicable) or the Park Assist Rear, then there will be an error message displayed on the infotainment screen.

Park Assist Front (if applicable):



Park Assist Rear:

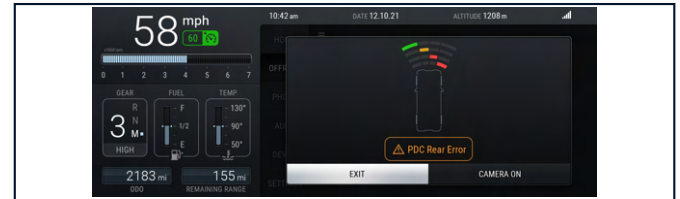

DRIVER SUPPORT AND FEATURES

REAR-VIEW CAMERA (OPTIONAL)

The wide angle Rear-View Camera makes it easier to manoeuvre the vehicle in tight spaces both on and off-road, making obstructions or low objects more visible when reversing.

Rear-View Camera Activation

When the vehicle is in 'Off-road Mode' or 'Wading Mode' the reverse camera can be activated manually inside the off-road settings.

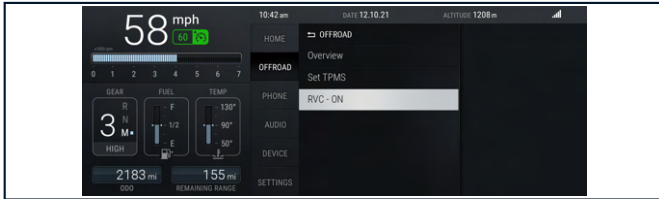

When the Rear-View Camera is activated, the camera screen will be displayed on the infotainment screen, along side the PDC display.



Rear-View Camera Deactivation

The Rear-View Camera can be switched off by pressing 'CAMERA OFF' on the infotainment screen.

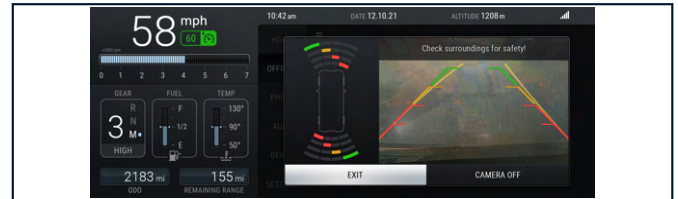

DRIVER SUPPORT AND FEATURES

Press 'CAMERA ON' to switch the Rear-View Camera back on again.

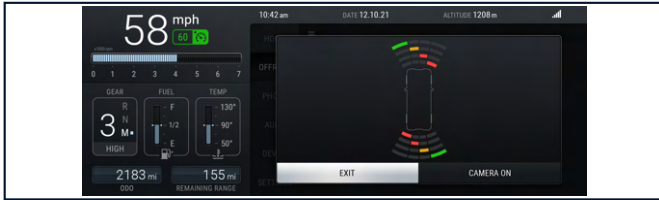

If the Rear-View Camera is unavailable, the camera screen will be replaced with a warning message.

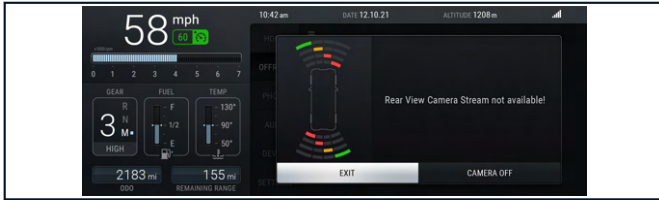

The Rear-View Camera overlay window can be closed at anytime by pressing 'EXIT' on the infotainment screen.

SOS EMERGENCY CALL (eCall)



WARNING: The eCall system is not a rescue service and INEOS cannot guarantee a response. It is not a substitute for appropriate preparation for a journey (particularly off-road/adventure/overlanding) and should not be relied on as the only method of notifying emergency services.

The eCall system provides the user with an emergency call system. The system uses the GPS satellite network to provide an accurate location for emergency services to find the site of an accident.

The eCall system can be activated either manually or automatically, once a voice connection is established, the green LED in the SOS button will be illuminated.

When the ignition is set to on, the red LED will illuminate on the SOS button, while the system is performing a self-test. The red LED, will be replaced by a green LED within one minute, if there are no errors. If the red LED is permanently on, contact an INEOS Partner for support.

Manual Operation

To Manually operate the emergency call system:

1. Open the eCall switch cover, located in the roof console.
2. Press and hold the button, until the green LED flashes.
3. After eight seconds, the vehicle will dial a emergency call operative to assist.

DRIVER SUPPORT AND FEATURES

Manually operate the eCall system, in the event of an accident not severe enough to deploy airbags, but still requires assistance from the emergency services. Or, if there is an incident, that does not involve yourself but the emergency services are required, such as, an accident next to your vehicle.



NOTE: The emergency call function, should only be used if you or others are in need of emergency assistance. The function is not for use in the event of a breakdown or any other similar non-emergency situations.

Automatic Operation

The eCall system is directly connected to the occupant restraint control system (ORC). When there is an incident or road collision with airbag deployment, the eCall system will automatically contact an emergency operative to advise. The operating Center will also receive a text message with information, such as, current location.



NOTE: If the emergency call is connected, but there is no response due to the occupants being unconscious, then the emergency services will be dispatched to the location of the vehicle.

Malfunction Warning

If there is a fault with the eCall System such as a broken component, then the eCall button LED will illuminate permanently red. In the event of a system fault consult with an INEOS partner.

ROADSIDE EMERGENCIES

First Aid Kit

The vehicle comes with a first aid kit. The kit is located in the rear door of the vehicle.

Warning Triangle (OPTIONAL)

The vehicle comes with one warning triangle (if applicable), the warning triangle is located in the rear door of the vehicle. The warning triangle is used to warn other drivers of your presence on the roadside. Use the warning triangle, to give other drivers time to safely adjust their speed and driving position.

Fire Extinguisher (OPTIONAL)

The fire extinguisher comes as part of the 'Roadside Emergency Kit Plus' option, if applicable. The fire extinguisher is located under the front passenger seat. The fire extinguisher is used for emergencies, please refer to the manufacturer's instruction label on the extinguisher.

Warning Vest

The vehicle comes with a hi-vis warning vest. The standard vest is located underneath the driver seat for quick access and the optional second vest is in the rear door with the first aid kit.



DRIVER SUPPORT AND FEATURES

Always keep the hi-vis warning vests with the vehicle and wear in the case of an emergency or breakdown.

Vehicle Tool Kit

There is a tool kit in the vehicle for use in an emergency, such as, changing a wheel at the roadside. The tool kit is located under the driver seat. To remove the tool kit, open the drivers side door, undo the retaining strap, and slide the tool kit out from underneath the seat when it is safe to do so.

Bottle Jack

-  **WARNING:** Make sure heavy luggage and any passengers are out of the vehicle before raising the vehicle with the bottle jack.
-  **WARNING:** Make sure the vehicle is on stable and level ground, before lifting the vehicle using the bottle jack.
-  **WARNING:** No persons should be under the vehicle for any reason when the vehicle is lifted on the bottle jack.

There is a bottle jack in the vehicle for use in an emergency, such as, changing a wheel at the roadside. The bottle jack is located in the rear loading area behind a service panel. Once the outer

service panel is removed there is a secondary inner panel that also needs to be removed.

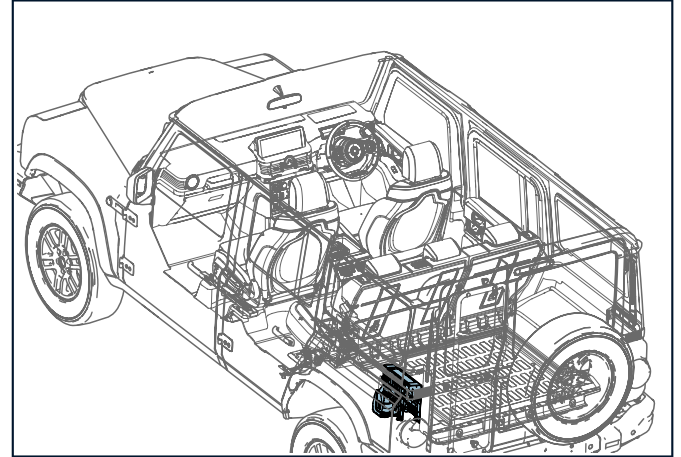

NOTE: Before using the bottle jack make sure there are no signs of damage or wear to the bottle jack. If there is damage or an issue with the bottle jack, consult immediately with your INEOS approved partner.

DRIVER SUPPORT AND FEATURES

Vehicle Jacking



WARNING: Only use the bottle jack to raise the vehicle on firm and level ground. This will ensure stability of both the bottle jack and the vehicle.



WARNING: The bottle jack itself must be located on firm and solid ground, clear stones or other debris from under the base of the bottle jack before use.



WARNING: Do not use the jack if you are unsure of the jacking point locations on the vehicle. Seek advice and support from an INEOS approved partner.



WARNING: Always check there are no objects or persons under the vehicle when using the bottle jack at any time. Failure to do this may result in serious injury or death.



WARNING: Do not jack up the vehicle with occupants inside or heavy luggage inside. This can result in the jack failing as the vehicle may be too heavy. This may lead to serious injury or death.



WARNING: Do not jack up the vehicle with occupants or heavy luggage inside. If towing, always secure and disconnect the trailer before proceeding to use the bottle jack. Failure to do so may result in the jack failing as the vehicle may be too heavy. This may lead to serious injury or death.



NOTE: It is recommended when jacking the vehicle up, that the wheels are chocked and the vehicle is in park P, to help ensure there is no unexpected vehicle movement.

To raise the vehicle using the bottle jack:

1. Make sure to close the release valve by turning it fully clockwise.
2. Position the jack between the two shock absorber mounting brackets on the axle.
3. Pump the lever up and down to raise the jack.



NOTE: Parts under the vehicle may be hot, be careful when under the vehicle. For example, the exhaust can be extremely hot if the vehicle is not allowed time to cool first.

To lower the jack:

1. Remove all tools and objects from beneath the vehicle, check to make sure there are no people or parts of the body underneath the vehicle.
2. Remove the lever from the bottle jack and slot on to the release valve.
3. Slowly rotate the release valve, anti-clockwise, to slowly lower the vehicle back to the ground, do this carefully to avoid sudden movements of the bottle jack and vehicle.

DRIVER SUPPORT AND FEATURES

VEHICLE RECOVERY



WARNING: Vehicle recovery and / or transportation must be carried out by personnel with advanced knowledge and qualifications. Recovery and transportation of a vehicle is extremely dangerous. If you do not seek help from suitably qualified personnel, there is a chance of serious injury or death.

Your vehicle should always be recovered on a vehicle transporter and should only be towed for short distances, for example, if it is causing an obstruction or if it requires winching onto a transporter. The transfer case must be neutralised, using the neutral screw in the side of the transfer case before towing the vehicle.



NOTE: INEOS recommend that the vehicle is transported with all four wheels off the ground using a flatbed or appropriate wheel lifting equipment. This method is preferable to other types of towing.

Front Towing Eyes

There are two front Towing Eyes welded to the frame. They are located on the front of the vehicle under the front bumper. The Towing Eyes can be used as a secure point for the vehicle to be towed.

TOW HOOK	MAXIMUM LOAD
Horizontal	40 kN
Vertical	30 kN

Rear Towing Eyes

There are two rear Towing Eyes welded to the frame. They are located on the rear of the vehicle under the rear bumper. The Towing Eyes can be used to tow other vehicles weighing up to a maximum weight of 3.5 tonnes.

TOW HOOK	MAXIMUM LOAD
Horizontal	35 kN
Vertical	22,5 kN
Centre	30 kN



NOTE: When towing a trailer using a trailer hitch, the maximum vertical center load (trailer nose weight) is 350 kg.

DRIVER SUPPORT AND FEATURES

Towing On All Four Wheels



WARNING: When towing the vehicle without the engine running, both the steering wheel and brake pedal will give greater resistance. The brake servo and the steering pump will not engage to provide assistance to the driver. This will mean greater force from the driver will be required to handle the vehicle.



WARNING: If the battery needs to be disconnected for any reason, the steering column must be unlocked first. Failure to unlock the steering column lock before disconnecting the battery, will mean the steering column will stay locked during towing. This will result in loss of control, leading to serious injury or death.



CAUTION: If there is a fault with the transmission or damage to the wheels and tyres of the vehicle, then the vehicle must not be towed and transported only. Towing a vehicle with transmission faults or a damaged wheel and tyre will cause further damage to the vehicle.



CAUTION: Towing with only two wheels on the ground can cause damage to the transmission. Towing with only two wheels on the ground is not recommended.



CAUTION: Do not tow the vehicle for a long distance. Towing is a method used for a short distance, for

example, to tow the vehicle to a suitable road or to a trailer.



CAUTION: Both prop shafts must be removed before towing the vehicle. Failure to do this will result in damage to the vehicle.



CAUTION: The towing speed should not be more than 30 mph (50 km/h) and the towing distance should not be more than 3 miles (5 km).

If it is essential to recover the vehicle by a towing method, such as, towing the vehicle to the roadside for recovery, follow this procedure:

1. Select neutral position in the automatic gearbox.
2. Set the differential to the unlocked position.
3. Rotate the neutralisation bolt clockwise in order to engage neutral. The bolt is located in the side of the transfer case.
4. Turn the key in the ignition barrel to position one, this will then unlock the steering column.
5. Release the handbrake.



NOTE: The key must remain in position while towing, do not try to change the position of the key in the ignition barrel, until towing has finished and the vehicle is stationary.

DRIVER SUPPORT AND FEATURES



CAUTION: Leaving the ignition on while towing will drain the battery, the vehicle lamps will activate for braking and directional indicating. Drive short distances when towing the vehicle.

Transporting The Vehicle



WARNING: When transporting a vehicle, be extremely careful and seek professional support. Transporting a vehicle can be extremely dangerous if not done correctly. Any unsafe actions may result in serious injury or death.

It is essential that the vehicle is secured safely and securely before transporting the vehicle. Always use suitably qualified professionals, to recover and transport the vehicle. A trailer specifically designed to transport this vehicle is recommended.

Front (OPTIONAL) and Rear (ACCESSORY) Winch



WARNING: Before using the winch, inspect for damage or signs of wear. Failure to do this may result in damage to the vehicle, serious injury or even death.



CAUTION: Do not misuse the winch, the winch is used for self-recovery purposes only. Failure to use the winch correctly may result in damage to the winch, winch components and the vehicle.

Before using the winch, the following inspections must be completed:

- > Winch should be well maintained and visually in good condition
- > Motors should not be exposed
- > All fasteners and connections must be checked
- > The cable must be inspected for signs of wear, such as, damage, cuts, and fraying.

The winch cable is held onto the drum through friction. Check the cable is properly attached and not slipping on the drum. Never unwind the cable completely, only unwind until the red marking on the rope is visible. To ensure there is enough friction for your pull, unwind the cable and spool it up under load (e.g. pull the weight of the car on a slight slope).

The winch is operated with a wireless remote control. The winch must be switched on by pressing the switch located in the roof console. Switch off the winch using the same switch in the roof console.

For further details, please refer to the winch documentation supplied with the vehicle.

Jump Starting The Vehicle





WARNING: The donor vehicle must have a battery with the same volts, the battery is 12 volts. Failure to do this may result in serious injury or death.

DRIVER SUPPORT AND FEATURES

 **WARNING:** Do not start the vehicle with a quick charger.

 **WARNING:** When connecting the negative jump lead to the grounding point, do not use the fuel lines, engine rocker covers or the intake manifold as grounding points.

 **WARNING:** Make sure that there is sufficient ventilation when charging the battery or jump starting the vehicle.

 **WARNING:** Do not connect a positive (+) terminal to a negative (-) terminals on the battery directly. This will cause serious injury or death. There are terminal points under the bonnet that must be used.

 **WARNING:** Do not allow the terminals of one lead to touch those of the other lead.

 **WARNING:** When using booster cables between both vehicles, be careful not to get the cables tangled or caught on any moving mechanical parts causing damage to the vehicle. If the cables do get caught, then this may result in serious injury or death.

 **CAUTION:** Connect batteries with only the same nominal voltage.

 **CAUTION:** If the battery does not hold charge after a jump start from a donor vehicle, then the vehicle must

not be driven until the vehicle has been checked by an approved INEOS partner. Repeatedly jump starting the vehicle can cause further damage.

A vehicle with a depleted battery can be started using jump leads and the battery of another vehicle. The battery is located under the rear bench seat of the vehicle, due to this, there are positive and negative terminals accessible in the engine bay.

Before jump starting the vehicle please be aware of the following points:

- > Use jump leads with insulated terminals and a cross section of at least 16 mm² (25 mm² for diesel engines).
- > Do not disconnect the discharged battery from the vehicle.
- > A discharged battery, can freeze at a temperature of 0 °C. Defrost the frozen battery before connecting jump leads.
- > Switch off all unnecessary electrical consumers.
- > The vehicles must not come into contact with each other during the jump starting process.
- > Apply the handbrake, transmission in neutral, automatic transmission in **P** (if applicable) to both vehicles.
- > Open the red positive terminal protection caps off both positive terminals or batteries (if applicable).

DRIVER SUPPORT AND FEATURES

When safety warnings have been considered and the necessary safety equipment and clothing has been prepared, the vehicle can be jump started.

Jump Start Procedure

1. Park the donor vehicle as close as possible, The vehicle batteries should be adjacent to each other, this reduces the space that the jump cables need to cross to connect the batteries.
2. Make sure the handbrake is applied to both vehicles.
3. The donor vehicle should be in neutral gear or park **P** if automatic.
4. Make sure both vehicles are switched off.
5. Connect the positive (+) cable to the positive (+) terminal, on the donor vehicle battery. Then connect the other end of the positive (+) cable to the positive (+) terminal on the vehicle with the depleted battery.
6. Connect the negative (-) cable to the negative (-) terminal on the donor vehicle.
-  **WARNING: Do not connect the last remaining negative (-) cable to the negative (-) terminal on the vehicle with the discharged battery. Only connect the last remaining negative (-) cable to an earth point for safety reasons.**
7. Connect the last remaining negative (-) connector, to an earth point, on the vehicle with the discharged battery.

8. Check the connections are secure and in the correct positions. Check that the cables are not caught on any moving or mechanical parts. Now start the donor vehicle engine and run at about 1500-2000 rpm for two to three minutes.
9. Now start the vehicle with the discharged battery, allowing both engines to run together for a further two minutes.
10. Switch the donor vehicle off.
11. Disconnect the negative (-) cables first, followed by the positive (+) cables from both vehicles.
12. Allow the vehicle with the depleted battery to idle for a while longer, this is to let the battery recharge.

It is recommended, to switch off the vehicle that originally had the depleted battery. Then try to restart the vehicle to see if the engine will restart again. If the vehicle restarts, this confirms the battery is recharging when the engine is running. Take the vehicle on a long drive to fully recharge the battery.

If the vehicle does not restart after the jump start procedure has been followed, consult with your INEOS approved partner to have the battery and/or the charging system checked and replaced if necessary.

DRIVER SUPPORT AND FEATURES

TOWING A TRAILER



WARNING: Whenever the vehicle is towing, always stay clear of the area between the vehicle and the towed object, such as, a trailer. Failure to do so may result in injury or death.



WARNING: Attach a trailer to the trailer hitch only. Attaching a trailer to any other part of the vehicle can result in reduced handling and loss of control.



CAUTION: Maximum towing weight of a braked trailer is 3500 kg. Do not exceed this towing weight.



CAUTION: Do not use high range when traveling at speeds less than 20 mph (32 km/h), while towing heavy loads. Otherwise the transmission may overheat. It is advised to use low range below 20 mph (32 km/h) when towing heavy loads.

Make sure the trailer is being used in accordance with the manufacturer's recommendations, and that you follow any applicable legislation.

Trailer Stability Assist

Specific Electronic Stability Control (ESC) calibration for use when towing. Trailer Stability Assist helps to control individual wheel slip, to prevent potential trailer sway.

The vehicle ESC must be in default mode for Trailer Stability Assist to operate. When Trailer Stability Assist is triggered, the tell-tale



will flash to warn the driver.

VEHICLE SECURITY

VEHICLE KEY BUTTONS 127

VEHICLE SECURITY

VEHICLE KEY BUTTONS



WARNING: Keep new and used Batteries away from children. If the batteries have been swallowed or are in any part of the body, seek immediate medical help.



WARNING: If the battery compartment does not close securely, stop using the product and keep it away from children.

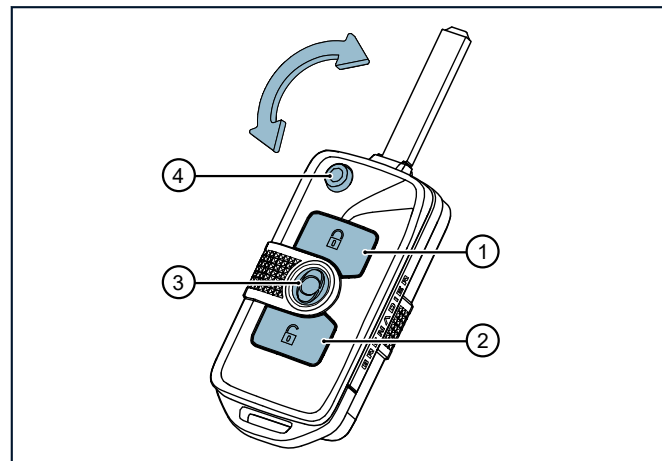

NUMBER	BUTTON	FUNCTION
1	Lock	Press to lock the vehicle and arm the security system.
2	Unlock	Press to unlock the drivers door.
3	Panic	The panic button, will set of the alarm of the vehicle.
4	Key Blade	Press the button to release the key blade, to manually unlock and lock the vehicle.

VEHICLE SECURITY

Key Fob Battery Replacement



WARNING: Keep batteries out of reach of children. If you think batteries may have been swallowed or placed inside any part of the body, seek immediate medical attention.



WARNING: If swallowed, a lithium button battery can cause severe or fatal injuries within 2 hours. Seek immediate medical attention.

The vehicle key is battery powered. The battery will need to be replaced dependent on usage, to ensure full functionality of the remote fob.

To change the battery, remove the back cover on the key fob, this will reveal the battery. Replace the battery and re-install the cover to the back of the key fob.



NOTE: Batteries should be disposed of at an appropriate recycling point. Do not dispose of old batteries in household waste. Dispose of old batteries in accordance with environmental regulations.

MEDIA AND INFOTAINMENT

OVERVIEW	130
HOME	137
OFF-ROAD	140
PHONE	143
DEVICE	148
AUDIO	150
SETTINGS	157
AUDIO OUTPUT SPECIFICATION	163
CONNECTIVITY	163

MEDIA AND INFOTAINMENT

OVERVIEW

Central Control Interface (CCI)

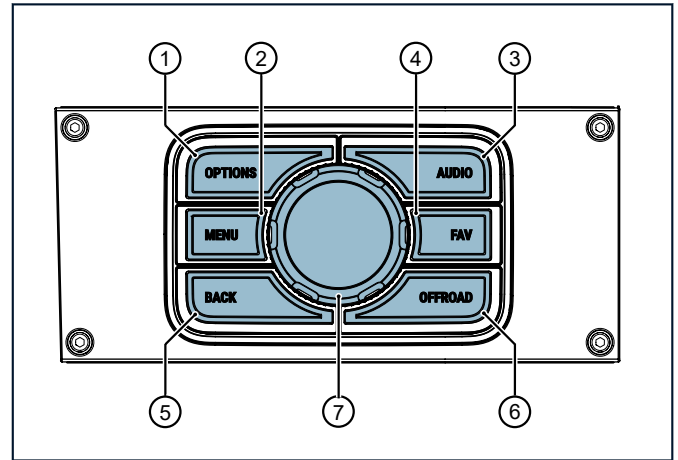

NUMBER	BUTTON	DEFINITION
1	OPTIONS	Opens or closes the option menu of the active area/focus.
2	MENU	Opens and closes the menu of the active area/focus.
3	AUDIO	Opens the audio menu.
4	FAVOURITE	Default switches to radio, can be changed in the settings.

MEDIA AND INFOTAINMENT

NUMBER	BUTTON	DEFINITION
5	BACK	Returns back to previous option or screen.
6	OFFROAD	Infotainment enters off-road screens.
7	ROTARY CONTROLLER	Directional movement, by moving left, right, up and down or rotating the rotary controller. Press inwards once, like a button, to confirm current selection.

To switch focus, such as, moving from the favourites bar to the radio frequency option, rotate the rotary controller.

To select the currently highlighted item, push the rotary controller inwards once. You can rotate the rotary controller to select items within the currently active window.

Pushing or pulling the rotary controller will switch the focus between the available windows. When using the touch function, you can press the buttons directly or scroll up and down by swiping up and down on the infotainment screen.

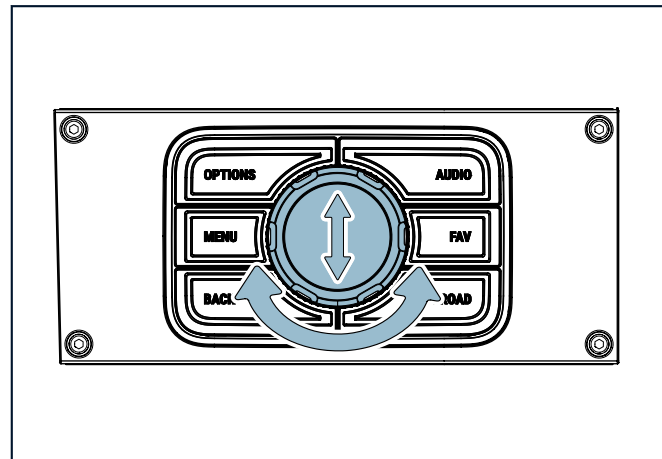

MEDIA AND INFOTAINMENT

If the last item of the window is reached, pressing the down button will do nothing, the user will have to navigate in the reverse order.

STEERING WHEEL CONTROLS

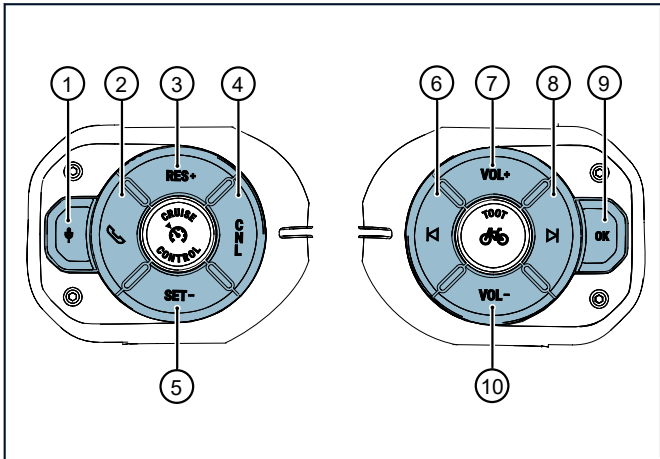

1. Voice activation (Apple CarPlay and Android Auto only)
2. Start and end calls
3. Incremental increase
4. Cancel

5. Incremental decrease
6. Previous track
7. Increase volume
8. Next track
9. OK - Confirm selection
10. Decrease volume

VOLUME AND MUTE

To mute the audio, press the mute button (9), located on the centre console. Press the mute button again, to un-mute the audio. Rotate the audio knob surrounding button (9), to adjust the audio volume.

Alternatively using the steering wheel controls, press button (7) to increase the volume or button (10) to decrease the volume.

HIGHLIGHT CURSOR

The highlight cursor is used when navigating with the infotainment screen to indicate the current position of the user.

MEDIA AND INFOTAINMENT

No highlight cursor:

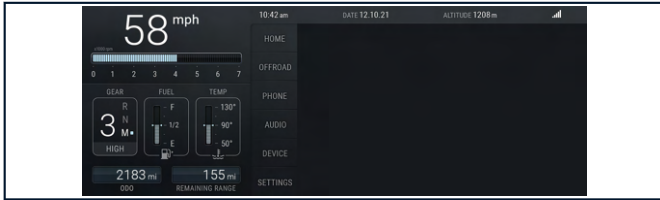

Pressed highlight cursor:

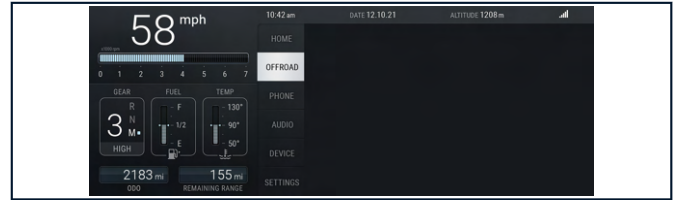

Highlight cursor:

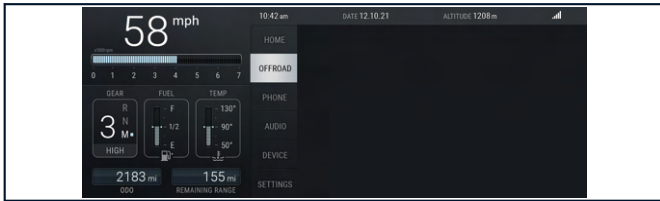

Active/selected option:

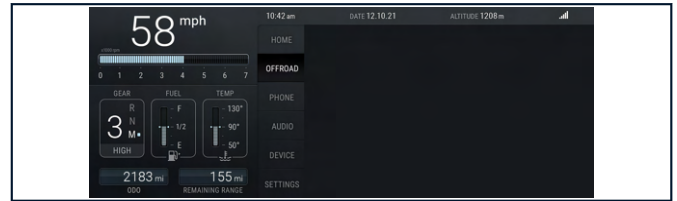

By default, the highlight cursor will be visible on the 'HOME' menu tab. When navigating through the menu, the highlight cursor will be on the selection that was last activated in that menu.

MEDIA AND INFOTAINMENT

The highlight cursor will be grayed out if a selection is not possible.

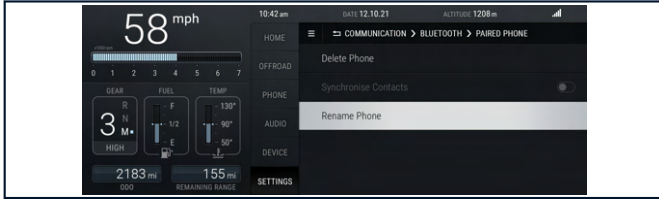

i *NOTE: If there is an issue with the system, such as, a failed connector or sensor issue then '--' will be shown instead of the value. If this happens contact your INEOS partner for further support.*

OPTIONS MENU

The option menu can be opened, by either touching the option menu button next to the 'HOME' tab on the infotainment screen or by pressing the 'OPTIONS' button (1) on the CCI.



The options menu can be closed by pressing the button a second time, pressing the 'OPTIONS' button on the CCI, or by pressing the 'BACK' button (5) on the CCI.

i *NOTE: The option menu button will be grayed out if it is not possible to select or open. For example, when inside the setting menu, the options button will not be selectable.*

When opening the option menu, continue to use the rotary controller to navigate the options available.

NAVIGATION BAR

There is a navigation bar at the top of each menu, showing your current location within the menu structure. Every time the user selects an option, the navigation bar displays the route taken and the names of the options selected so far.

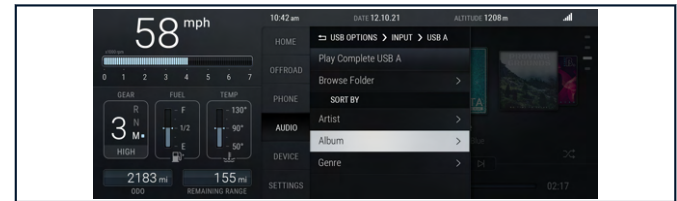

When there is not enough space to display the names of selected options, the navigation bar will replace the route names with

MEDIA AND INFOTAINMENT

arrows. The arrows will indicate the level of the menu structure selected so far.

This image is an example of 'USB OPTIONS' and 'INPUT' hidden as the first two arrows:

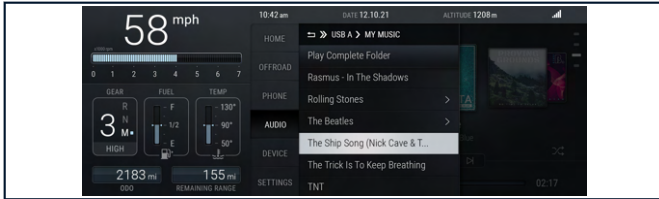

This image is an example of 'USB OPTIONS', 'INPUT' and 'USB A' hidden as the first three arrows:

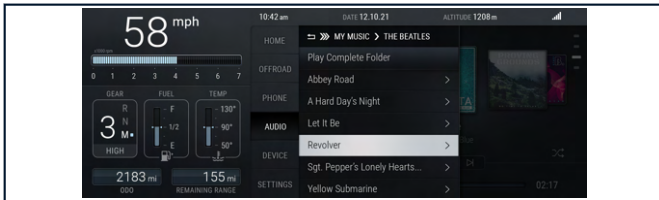

KEYBOARD

The keyboard will appear, once an option that requires input is selected.



If the field that requires the input is not visible, an input box will appear above keyboard.

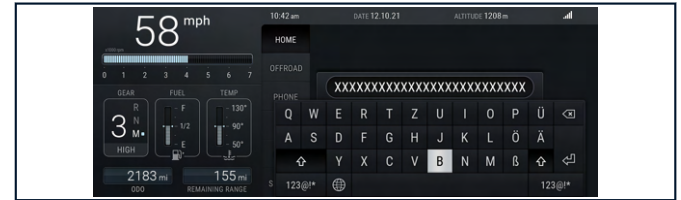

To close the keyboard, press the 'BACK' button on the CCI or touch anywhere outside the keyboard.

MEDIA AND INFOTAINMENT

When the user selects the globe symbol on the keyboard, an overlay will appear with the options to change the keyboard layout.

INFORMATION HEADER

The info bar is visible at the top of the infotainment screen. The info bar displays information, such as, time, date, altitude and phone signal.

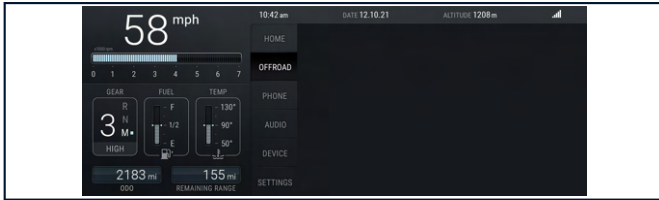

The info bar will change and show the information required, when using certain functions.

The audio overlay will only appear if the 'AUDIO' screen is not active.



The active call information will be visible, until the call is ended.

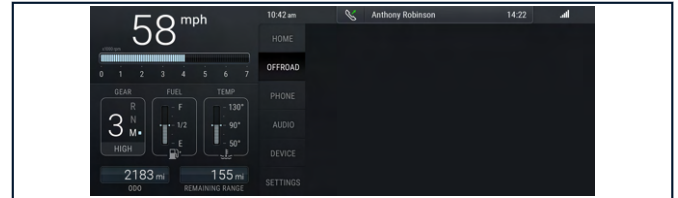

MEDIA AND INFOTAINMENT

The temperature info, will show changes in the internal temperature settings.

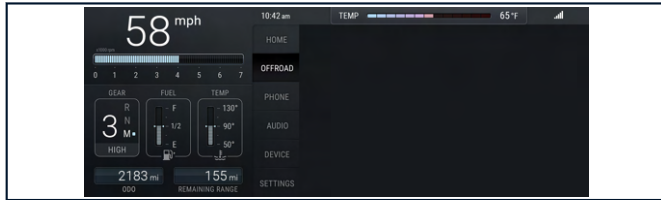

The volume control info, will show when the user adjusts the volume levels.

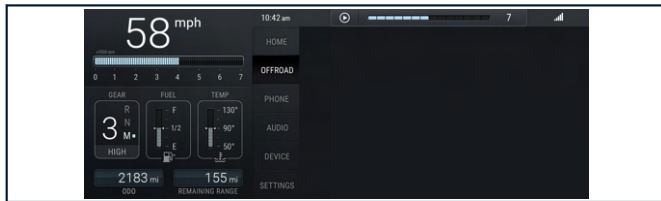

HOME

The home tab is subdivided into two sections, also referred to as a focus. The top section is the audio focus, showing audio information, such as, currently playing and upcoming tracks in the

play list. The bottom section is favourites focus, showing contacts from a connected mobile phone.



By default, the audio focus will be visible, however the system will remember the last focus selected. For example, if the user navigates from browsing the favourites focus, to the 'SETTINGS' tab, then returns again to the 'HOME' tab, the favourites focus will continue from the position last used.

If there is no favourite contacts available to display in the favourites focus, then text, such as, 'No Favourite Contact' will be displayed.



MEDIA AND INFOTAINMENT

If there is no audio play list available, the audio focus will display text stating 'No Playlist'.

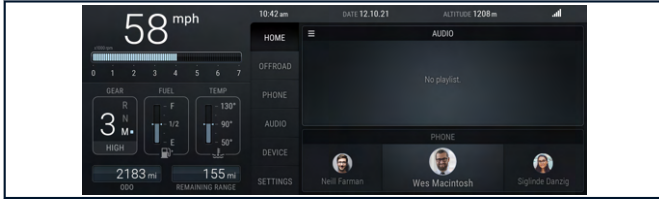

Home Audio

When the audio focus is active, depending on the source of the audio, the user will see the following displays within the 'HOME' tab:

FM/AM radio with one information line displaying frequency.



DAB displaying album cover (if applicable), with two lines of information. Line one, showing the station name and line two, showing the Frequency.



Bluetooth device displaying album cover (if applicable), with two lines of information. Line one, showing the track name, line two, showing the artist and album name.



USB device displaying album cover (if applicable), with two lines of information. Line one, showing the track name and line two, showing the artist and album name.

The active track being played, will always be positioned in the center of the audio focus.

MEDIA AND INFOTAINMENT

If the user selects the favourite focus, while the audio focus is active, then the favourite focus will enlarge to indicate screen priority. The audio focus will decrease in size.



Favourites

The favourites focus shows contacts from connected mobile phone. The favourite focus will display a maximum of three contacts simultaneously. If there are more than three favourite contacts then the user can swipe through the list using the touch screen or the rotary controller.

The middle contact of the three contacts simultaneously shown will be highlighted, revealing contact numbers listed for that specific contact.



If there are multiple numbers for a contact, a small downwards arrow will appear. Scroll down the list to reveal more numbers using the rotary controller, touchscreen or steering wheel controls.

If there is no mobile phone connected, then the favourite focus will display text, such as, 'No phone connected. Please go to settings.'

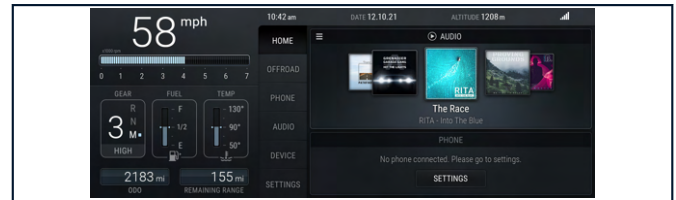

OFF-ROAD

Attitude

Selecting the 'OFFROAD' mode tab, displays a menu of features relevant to using the vehicle off-road. The first sub-tab is the attitude screen, displaying the following information:

- > Wheel angle.
- > Altitude.
- > G-Force.
- > Pitch.
- > Roll.



Off-Road Temperature

The second sub-tab, will display temperature information, such as:

- > Tyre pressures of all four tyres in use, this excludes the spare wheel tyre.
- > Tyre temperatures of all four tyres in use, this excludes the spare wheel tyre.
- > Engine temperature.
- > Automatic transmission gearbox temperature.
- > Two-speed transfer case temperature.



Pathfinder Navigation Mode

The third sub-tab is the pathfinder navigation mode. The screen will consist of the home button near the top and three further options, such as, 'Record Path', 'Follow Path' and 'Roadbook'.

- > Follow Path - Follow an existing GPX document.
- > Record Path - Record and create a new GPX document.

MEDIA AND INFOTAINMENT

> Roadbook - Manually record a route.

Follow Path

Once the user has recorded the path required, the path can be followed using the recorded way points. When the user clicks on the next way point, the compass will navigate the user in the direction required, to reach the next way point. While following the compass direction, the user can see the distance to reach the next way point selected.



The user can select the next way point required or revert back to a previous way point by pressing the 'NEXT WAYPOINT' or 'PREVIOUS WAYPOINT' buttons on the infotainment screen. The user can also select the way point markers on the route line, by either pressing the infotainment screen or by using the rotary controls.

Record Path

The record path screen, may be used to record the path driven manually or automatically.

The user can add a way point by clicking on the record path button, otherwise the user can add a way point automatically. To automatically add way points over set distances, the user should switch on the automatic feature inside the menu options.

In the image below, the compass shows the direction of travel and the distance travelled.



Roadbook

The roadbook feature is used for rally driving and driving off-road. The passenger can compare the roadbook to a handheld roadbook for the planned trip. The user can adjust the distance between points, by using the minus or plus buttons on the infotainment screen. Press the minus or plus buttons, to decrease and increase the distance in increments of 100 meters. This is

MEDIA AND INFOTAINMENT

done by pressing the buttons on the infotainment screen or by using the rotary controls.



'TOTAL TRIP' is the total distance to be travelled and the 'PARTIAL TRIP' is the distance to be travelled to a checkpoint, thus helping the passenger understand the distance travelled so far.

Statistics

The fourth sub-tab, will display statistics information, such as:

- > Latitude.
- > Longitude.
- > Altitude.
- > Travel time.
- > Travel Distance.
- > Average Speed.
- > Average Fuel.



Off-Road Electrical

The fifth sub-tab, will display electrical information, such as:

- > Current charge.
- > Battery temperature.
- > Voltage.
- > State of charge.



MEDIA AND INFOTAINMENT

PHONE

Mobile phones can be connected to the infotainment system using Bluetooth or USB. The user can make calls, play stored music or use the mobile phone device for navigation purposes.

Select the 'PHONE' tab on the infotainment screen, using the touch screen or the rotary controller, to open the 'PHONE' section. When the 'PHONE' tab is selected, the system will show any connected devices. If there is no phone connected, a 'SETTINGS' button will be visible with a message stating 'No phone connected. Please go to settings. Please go to settings'.

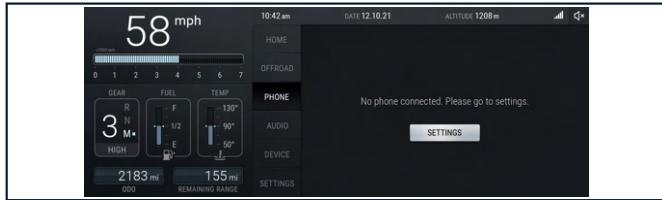

Connecting Phone

If there is no phone connected, the infotainment screen will show a 'SETTINGS' button. This will direct you to the device setting screen within the settings menu.

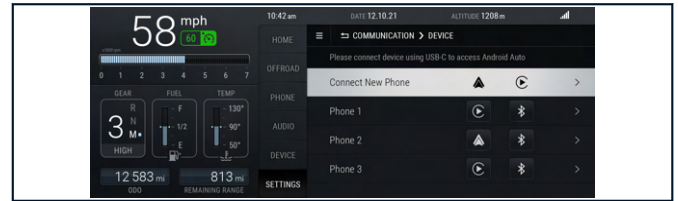

To connect a new phone, select 'Connect New Phone' on the infotainment screen. This will show a list of available phones. If there are multiple phones with the same name, the system will display the phone names with a number at the end.

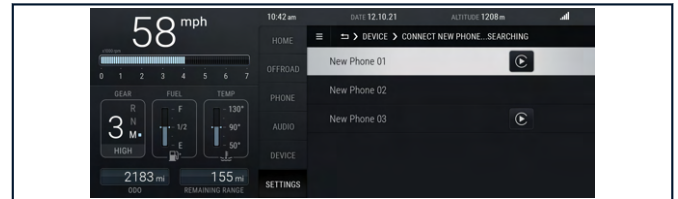

MEDIA AND INFOTAINMENT

Once a phone is selected, a security pairing PIN will be visible on the infotainment screen.

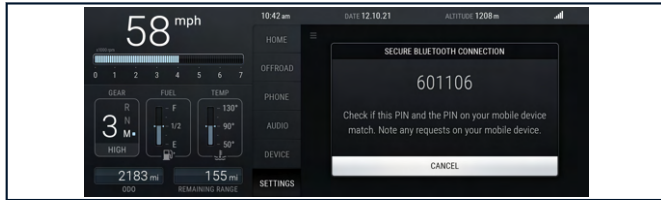

This pin will need to be entered into the phone you are trying to connect. If the PIN is entered incorrectly the connection will fail.

When the user clicks on the Bluetooth symbol during an active Apple CarPlay or Android Auto session, projection mode will be disabled and the mobile will be connected for native audio and phone.

Sub Menu

When a phone has been connected and the user is inside the 'PHONE' tab, five sub menus will appear on the infotainment screen.

Favourites

The 'FAVOURITES' menu will show a list of all the saved favourite phone contacts. It will display the image, name and phone number of each favourite.

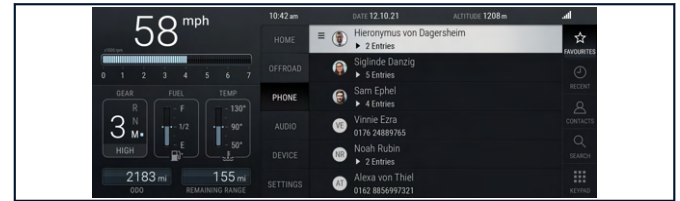

Recent

The 'RECENT' menu, will show a list of the call history. The contact image, name and number will be visible, along with the time of call and type of call.

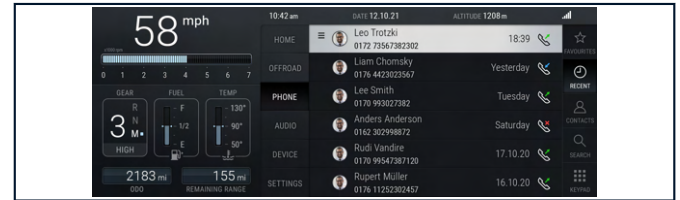

MEDIA AND INFOTAINMENT

If a call was dialed, received or not received within the current day, then the time of the call will be visible. Calls from the previous day will be shown as 'Yesterday'. Calls up to a week before the current day will be shown as the specific day, such as, 'Tuesday'. Any call type over a week old will be shown as a date of when the call was dialed, received or not received.

Contacts

The Contacts menu shows the synchronized contacts of the connected phone. The contact name and phone number of the contact will be visible including an image set for the contact.

If no name for a contact is available then the name will be left blank. If the contact selected has more than one phone number assigned to it, then in the place of the phone number will be an arrow followed by the number of phone numbers assigned to that contact. Select the contact to reveal the entries assigned to the contact. There is a maximum of five phone numbers per contact.

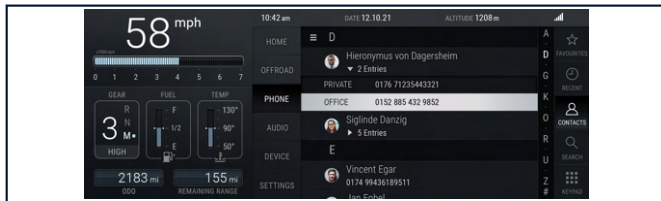

There is an alphabet bar to allow for faster navigation through the contact list. When using this bar, a floating cursor (D in the image) will appear and indicate the currently selected letter. This cursor is

shown for two seconds. If there are no contacts associated with the letter chosen, then the floating cursor will jump to the next available letter with contacts.

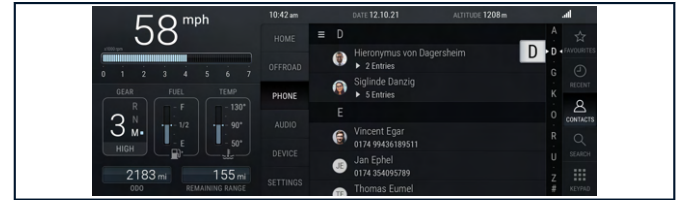

Search

The user can search for available contacts by typing in their names. The keyboard will pop up automatically, here the user starts to type the name of the contact they want to search. The contacts will appear according to the input by the user. If there is no result, then the screen will display a message stating 'No Result'. If there is no input by the user, then all contacts will be shown.

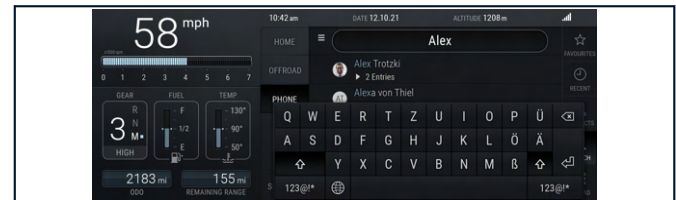

MEDIA AND INFOTAINMENT

Keypad

The user can use the keypad menu to search available contacts by number or to dial a number that is not already saved. If no call is made and no search results are recognised from the number entered, then the screen will display 'No Results List'.

The call button will be disabled if the input box is left empty by the user. Once a number has been entered the call button will become available.

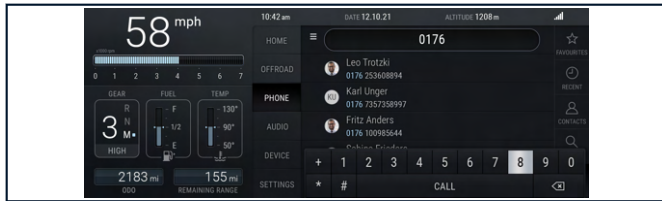

Incoming Call

When a call is incoming, the call details will be displayed on the infotainment screen.

By default the cursor will be on the 'ACCEPT' button.

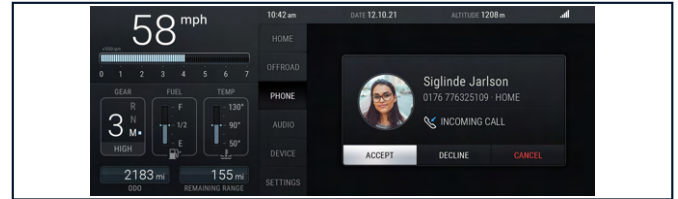

There will be three buttons visible when an incoming call screen is displayed.

BUTTON	DEFINITION
ACCEPT	Accepts the call and the screen jumps to the active call screen.
DECLINE	Declines the call and continues where the user was when the call was received.
CANCEL	Dismisses the dialog window and switches back to the previous screen.

Dialling Call

When a call is dialled, the call details will be displayed on the infotainment screen.

MEDIA AND INFOTAINMENT

By default the cursor will be on the 'CANCEL' button. If the call is accepted, the infotainment screen will jump to the active call screen.

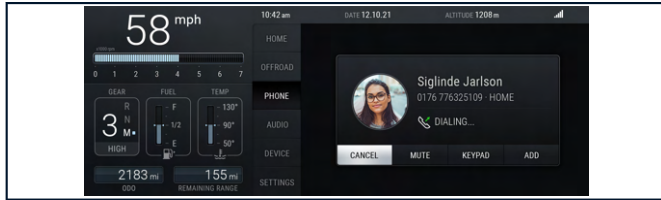

While the call is dialling, there will be four buttons visible.

BUTTON	DEFINITION
CANCEL	Dismisses the dialog window and switches back to the previous screen.
MUTE	Mutes the microphone in the vehicle and the button changes to 'UNMUTE'.
KEYPAD	Opens the number key pad.
ADD CALL	Current call is placed on hold, contact list opens with the sub menu options available. If the user starts a new call, the current call on hold ends.

Active Call

When a call is answered and becomes active the screen will display the caller contact details and a timer showing the time spent so far on the call.

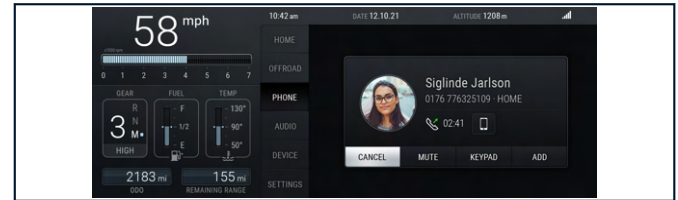

BUTTON	DEFINITION
CANCEL	Dismisses the dialog window and switches back to the previous screen.
MUTE	Mutes the microphone in the vehicle and the button changes to 'UNMUTE'.
KEYPAD	Opens the number key pad.
ADD CALL	Current call is placed on hold, contact list opens with the sub menu options available. If the user starts a new call, the current call on hold ends.

MEDIA AND INFOTAINMENT

Header Call Bar

The call info bar will appear at the top of the infotainment screen if the user switches from the call window.

There will be a different info call bar depending on the state of the call. If the user is calling a contact and switches to another screen then the following info call bar will be displayed:

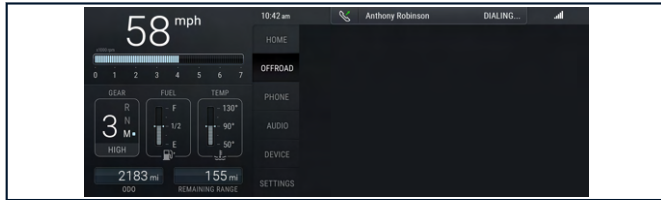

During an incoming call, if the user switches away from the call window without accepting or declining then the following info call bar will be displayed:

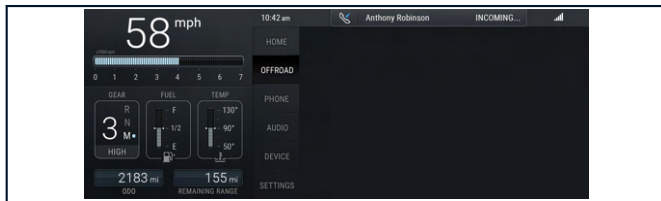

The user can recover the call window by either, touching the call section in the info bar or use the option menu followed by 'Recover Call Dialogue' option.

DEVICE

The 'DEVICE' menu will show devices that have been previously paired and stored. If the connected device supports Android Auto or Apple CarPlay, then the 'DEVICE' menu will become the default location to operate the associated features.

CONNECTING PHONE DEVICE

If no phones are connected, the user can click on the device button and the settings page will appear directly.

To connect a new Phone, select 'Connect New Phone'. This will start the Bluetooth discovering mode and will show a list of available phones.

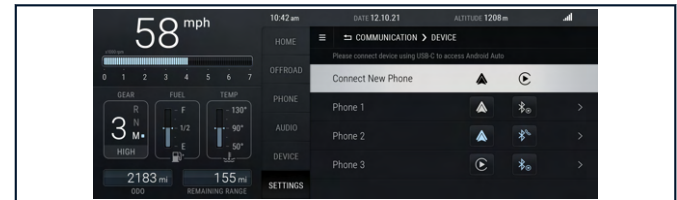

MEDIA AND INFOTAINMENT

i *NOTE: If there are multiple devices with the same name, the system will display the name assigned with a number at the end. For example, If there are two phones connected, both called Sam's Phone, then they will be displayed as Sam's Phone and Sam's Phone-1.*

Once a phone is selected, a security pairing PIN will appear on the infotainment screen. Match the security PIN on your phone to confirm connection.

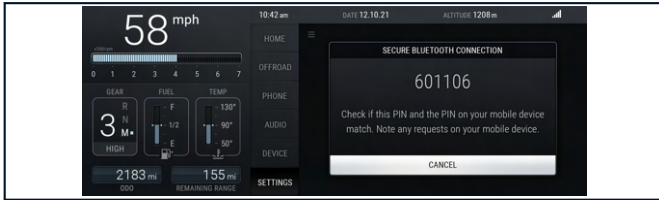

CONNECTING APPLE CARPLAY

i *NOTE: Apple CarPlay requires IOS 13 and above to be compatible. IOS 12 and below may result in compatibility errors.*

i *NOTE: Hotspot should be set to on, for wireless Apple CarPlay to work.*

After connecting the phone using Bluetooth, Apple CarPlay will be displayed automatically. If the phone is being connected for the first time, there will be an intermediate screen asking the user to agree to the privacy policy.

If the connection fails, a message will be shown on the infotainment screen.

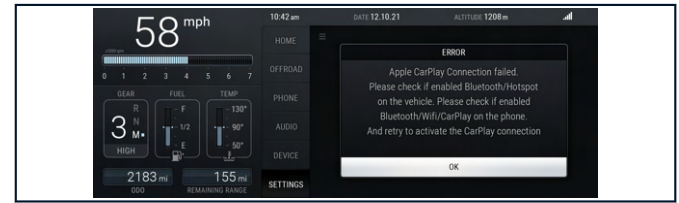

If a device connected to the infotainment system supports wireless Apple CarPlay, then you will be asked to connect once the phone device has been paired.

If there is already a wireless Apple CarPlay connection or a wired Android Auto connection, at the time of connecting the USB

MEDIA AND INFOTAINMENT

connection, a prompt will show on the screen, from which you can switch to the newly connected device.

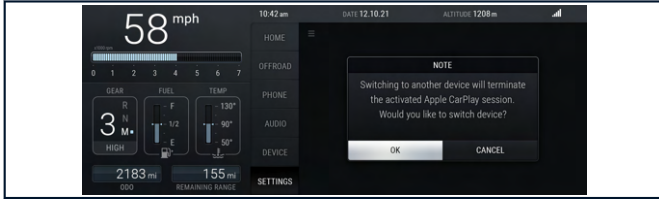

CONNECTING ANDROID AUTO

To connect your device to access Android Auto, follow this procedure:

1. Connect the device using a USB-C connection.
2. A pop up message will be displayed on the infotainment screen, asking the driver to 'stop the car and follow instruction on your phone'.

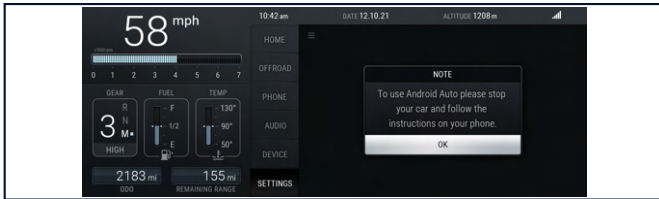

3. A message will pop up on the phone device, instructing the user on how to connect.
4. Once the instructions have been followed and completed on the phone device, press 'OK' on the infotainment screen.
5. If the connection has failed, then press the 'OK' button on the infotainment screen and start again from the beginning of the procedure.
6. The 'DEVICE' menu tab will now change to the Android Auto symbol, confirming the connection.



AUDIO

When the audio tab menu is selected, Apple CarPlay connected by wireless connection, will always be shown on the screen. However,

MEDIA AND INFOTAINMENT

you can navigate through other audio source's using the lined indicators on the edge of the screen.

The audio sources are:



MENU LEVEL	AUDIO SOURCE	DEFINITION
1	Apple CarPlay	Apple CarPlay will be shown as priority, if connected using a wireless connection.
2	Radio	Radio - AM/FM and DAB.
3	USB	USB connected devices - Phone and USB stick
4	Bluetooth	Devices connected using Bluetooth such as a phone or tablet.

Audio Options Menu

Press the options menu to view and select:

1. Source (Radio waveband)
2. Auto seek all stations
3. Delete current station

4. Add to favourites
5. Traffic announcements

MEDIA AND INFOTAINMENT

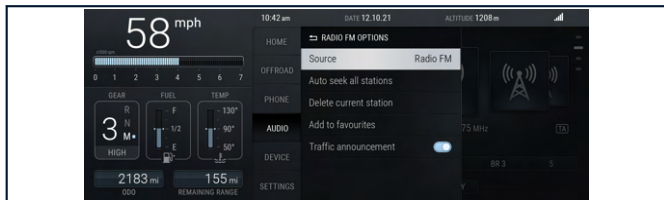

If the radio is set on DAB, then 'Add to favourites' will not be selectable.

Traffic announcements on and off button will be available in the radio options list if set on the 'FM' screen at the time of selecting the radio options button. Traffic announcements will be active by default.

OPTION MENU LIST	DEFINITION
Source	Pressing the source button in the option menu, will give you a list of frequency options.
Auto seek all stations	This will add all found stations to a preset radio list (not favourites). The first station found will start playing.
Delete current station	Press to delete the current station from the preset radio list.
Add to favourites	Add station to the favourites or remove from favourites if already saved.
Traffic Announcements	Press to switch off or on the traffic announcements.

Tuner

FM/AM



DISPLAY FOCUS	DEFINITION
Station list	Display available FM/AM stations.
Current frequency	Currently selected frequency.
Five favourite frequencies	Saves up to five frequencies to the favourites by long pressing the frequency. Short press frequency to start playing the station.
Frequency button	Pop-up dialogue to search previous or next station.

To switch from one focus to another, use either the rotary controls or the touch screen. Move the rotary knob up or down and the focus will switch between the station list, current station, favourites and the frequency button.

When the 'FREQUENCY' button is pressed, a pop-up dialogue will appear to change the frequency. The frequency can be changed in this dialogue box by either using the touch screen or the rotary

MEDIA AND INFOTAINMENT

controls. Once the correct frequency has been found, press the 'OK' button to close the dialogue.



DISPLAY FOCUS	DEFINITION
Five favourite stations	Saves up to five stations to the favourites by long pressing on the station. Short press the station to start playing.

DAB



USB

When a USB device is connected, the screen will display any artist or cover information if it is available. Otherwise a default image will be shown. The information shown below the cover image is as shown:

- > Song name
- > Artist - Album name

DISPLAY FOCUS	DEFINITION
Station list	Display available DAB stations.
Current frequency	Currently selected Station.

MEDIA AND INFOTAINMENT

When a track is playing and the user is scrolling through the cover images, the information of the currently playing song will be visible above the cover images.

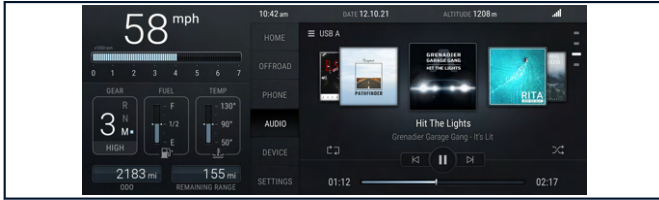

On the screen you will be able to select repeat, shuffle, play, pause, stop, or adjust the track time bar. When the focus is on the play list and cover information, use the rotary knob or the touchscreen to scroll through the play list. Press the back button to restart current track from the start.

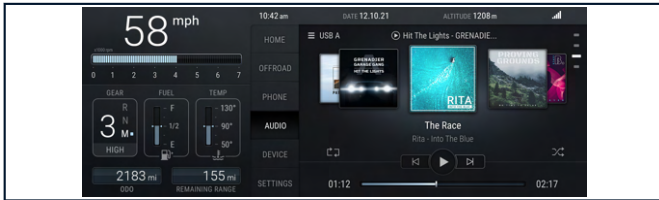

If the focus is on the time bar at the bottom of the screen, rotate the rotary knob to move forwards and backwards along the bar.

Press the rotary knob inwards to start playing or pause the track. This can also be done using the touchscreen.



NOTE: The play, pause, skip, repeat and shuffle buttons can only be activated using the touchscreen. The rotary controller will not be able to activate the quick touch buttons. Go to the USB options menu to adjust repeat and shuffle using the rotary controller.

USB Options

When a USB is connected and the user is inside the 'AUDIO' tab menu, press the options menu to see the USB options.

Inside the USB options menu, you will be able to select the following options:

USB OPTIONS	DEFINITION
Input	Select between available USB devices
Shuffle	Set shuffle to active or inactive
Repeat	Toggle between repeat all songs in play list or to repeat single track.



NOTE: Shuffle and repeat are not supported for Android Auto . Shuffle and repeat for Apple CarPlay will be operational through the app itself.

MEDIA AND INFOTAINMENT

Select 'Input' to navigate through the USB devices available. When you have selected a USB device, you will be able to manage content, control whether to play the complete USB or play any sub folders created.

Bluetooth

When a Bluetooth device is connected, the screen will display the information of the current track selected to play, if it is available. Otherwise a default image will be shown. The information shown below the cover image is as shown:

- > Song name
- > Artist - Album name



i *NOTE: The information for the track playing is completely dependent on the Bluetooth device connected.*

On the screen you will be able to select repeat, shuffle, play, pause, stop, or adjust the track time bar.

If the focus is on the time bar at the bottom of the screen, rotate the rotary knob to move forwards and backwards along the bar. Press the rotary knob inwards to start playing or pause the track. This can also be done using the touchscreen.

i *NOTE: The repeat and shuffle buttons can only be activated using the touchscreen. The rotary controls will not be able to activate the quick touch buttons. Go to the Bluetooth options menu to adjust repeat and shuffle using the rotary controls.*

Bluetooth Options

When a Bluetooth device is connected and the user is inside the 'AUDIO' tab menu, press the options menu to see the Bluetooth options.

Inside the Bluetooth options menu, you will be able to select the following options:

OPTIONS	DEFINITION
Input	Select between available connected devices
Shuffle	Set shuffle to active or inactive
Repeat	Toggle between repeat all songs in play list or to repeat single track.

MEDIA AND INFOTAINMENT

SETTINGS

Navigate the settings menu by either the touchscreen or the rotary controller.

The settings menu has the following selectable options:

- > General.
- > Display Settings.

- > Vehicle Functions.
- > Acoustic Settings.
- > Communication.
- > Pathfinder File Transfer.

General

GENERAL SETTINGS	DEFINITION
Language	Opens the language selection window, here the user can select the preferred language.
Unit	Opens the unit menu, here the user can set the preferred visual units for Speed, Temperature, Pressure, Distance and Fuel. For example, °C or °F.
Time / Date	Here the user can set the time and date to automatic, change the date and time format, select the time zone and select daylight saving time to on or off. If the user switches off automatic, then there will be the option to manually set the time and date.
LHD / RHD	The infotainment screen display can be set to left hand drive or right hand drive
Rotation direction of CCI	The rotational direction of the rotary controller can be changed. For example, the user may want to change the rotation, from clockwise to anti-clockwise, when rotating the control to the right.
Order of Contact Name	The user can select to view contact names as surname forename or forename surname.

MEDIA AND INFOTAINMENT

GENERAL SETTINGS	DEFINITION
CCI Favourites	The user can set what is registered as the favourite button. The user can call a contact by pressing the favourite button without the need for confirmation. The contact will need to be registered as the favourite button.
Reset General Settings	Reset general settings to the default values, the user will be asked to confirm before resetting.
Reset All	Resets all settings to the default values, the user will be asked to confirm before resetting.

Display Settings

The 'DISPLAY' menu consists of the following options:

DISPLAY SETTINGS	DEFINITION
Display Brightness	Set the brightness of the infotainment screen.
Configure Info Areas	Configure the information visible, such as, Average Fuel, Average Speed, Battery Charge, Trip Distance, Outside Temperature, Audio Source, Date, Travel Time and Odometer.
Reset Display Settings	Resets all display settings to the default values, the user will be asked to confirm before resetting.

Vehicle Functions

The 'VEHICLE FUNCTIONS' menu consists of the following options:

MEDIA AND INFOTAINMENT

VEHICLE FUNCTIONS	DEFINITION
Instrument Illumination	Set the brightness of the illuminated instruments.
Central Locking System	Settings can be set by the user, such as, Drive away locking, Selective Locking, Leaving Home Light Timeout, Remote Lock Feedback, Auto Door Unlock, Follow Me Home and Re-lock Remote Unlocked Door.
Park Distance Control - Front Deactivation	Here the front PDC can be deactivated, resulting in the four front sensors being switched off.
Vehicle Information	The user can see information, such as, Engine Oil levels and temperatures, AdBlue levels, Tyre Pressure, Battery, Service Intervals, VIN number, Total Distance Driven, Software (SW) Version and Active Warning Messages.
Speed Warning Sound	An acoustic warning sound will be heard when the vehicle reaches the set speed.
Passenger Airbag	Here the Passenger Airbag can be switched off or on.
Daytime Running Light	Daytime Running Light can be switched off or on.
Trip Information	Shows trip values for TRIP A and TRIP B. They can both be reset individually.
Reset Vehicle Function Settings	Resets all vehicle function settings to the default values, the user will be asked to confirm before resetting.

Acoustic Settings

The 'ACOUSTIC SETTINGS' menu consists of the following options:

MEDIA AND INFOTAINMENT

ACOUSTIC SETTINGS	DEFINITION
Equalizer	Set the Equalizer settings to the preferred frequency.
Fader / Balance	The Fader / Balance (if applicable) can be chosen for the speaker outputs within the vehicle.
Volume Settings	Here the volume settings can be set by the user. Settings, such as, the volume at Vehicle Start, Volume Minimization, Speed Dependent Volume Control and Notification Volume.
PDC Sound	Here the PDC sound volume can be adjusted between a range of 0-14. The higher the number the higher the volume will be.
Input Sound	The input sound volume can be adjusted in a range of 0-14. The higher the number the higher the volume will be.
Warning Sounds	The Warning Sounds can be set to either Low, Middle or High volume.
Reset Acoustic Settings	Resets all acoustic settings to the default values, the user will be asked to confirm before resetting.

Communication

The 'COMMUNICATON' menu consists of the following options:

MEDIA AND INFOTAINMENT

COMMUNICATION SETTINGS	DEFINITION
Device List	Connect new device or see connection status of known devices. The user can select connected device to see device settings, such as, Hands Free Call (if applicable), Synchronize Contacts, Audio Streaming, Rename Device and the option to delete the device.
Bluetooth	Opens the Bluetooth menu. Here you can switch Bluetooth on or off, turn on or off Bluetooth visibility and change the name of the Bluetooth device.
WIFI Hotspot Active and Visible	Switch WIFI Hotspot on or off and to view settings.
Reset Communication Settings	Resets all communication settings to the default values, the user will be asked to confirm before resetting.

Pathfinder File Transfer

The 'PATHFINDER FILE TRANSFER' menu consists of the following options:

- > USB A
- > USB C

> Hard Disk Drive (HDD)

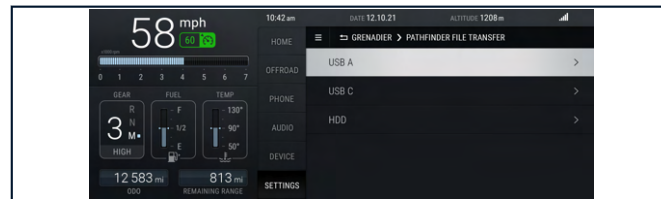

MEDIA AND INFOTAINMENT

PATHFINDER SETTINGS	DEFINITION
USB A	Here, the user can view the GPX Collection Folder and any saved GPX Files on the USB device. GPX files can be imported one at a time or all files at once. GPX Collection Folders can be imported one at a time, all files at once or as a complete folder.
USB C	Here, the user can view the GPX Collection Folder and any saved GPX Files on the USB device. GPX files can be imported one at a time or all files at once. GPX Collection Folders can be imported one at a time, all files at once or as a complete folder.
HDD	Here, the user can view the GPX Collection Folder and any saved GPX Files. GPX Collection Folders and GPX files, can be exported, deleted or renamed.

Below is an example of the USB, GPX Files and GPX Collection Folder options:



Below is an example of the HDD, GPX Files and GPX Collection Folder options:



MEDIA AND INFOTAINMENT

AUDIO OUTPUT SPECIFICATION

There are four speakers inside the vehicle, one located inside each door of the vehicle.

The minimum audio speaker output specification is 4x25 Watt true Root Mean Square (RMS). The speakers are rated individually at 4ohm each delivering high quality sound for long periods of time.

The USB A port provides a 2,4A charging current and the USB-C port provides a 3A charging current.

The USB A and C are covered by a cap to ensure they are IP54 compliant.

The cap will latch when closed to ensure sealing compression to give feedback when the cap is closed.

CONNECTIVITY

Front Data-In USB Ports

The front data-in USB Ports, are located inside the Central Stowage Tray or optional Central Stowage Box Lockable, and identified by the  symbol on the cap cover.

There are two types of USB port, one type A and one type C port. Both USB ports transfer data with the USB 2.0 protocol and data connection to the head unit and provide power according to the BC 1.2 charging standard to the connected USB device.

Auxiliary Charge Points (OPTIONAL)

Additional charging points for all of your devices. This option provides one USB-A and one USB-C port for the rear passengers, and a 12V socket in the loadspace.

The USB charging points are identified by the  symbol on the cap cover.

CLIMATE CONTROL

CENTRE CONSOLE CLIMATE CONTROLS	165
HEATED FRONT SEATS (OPTIONAL)	165
FAN SPEED SETTING	165
TEMPERATURE AND AUTO SETTING	165
AIR FLOW ZONES	166
RECIRCULATION	166
AIR CONDITIONING	166
WINDOW DEMIST REAR	166
WINDOW DEMIST FRONT	166
VENT ADJUSTMENT	166

CLIMATE CONTROL

CENTRE CONSOLE CLIMATE CONTROLS

The Climate Control buttons are numbered within the text in this section. Where there is a number in brackets, refer to this Centre Console image.

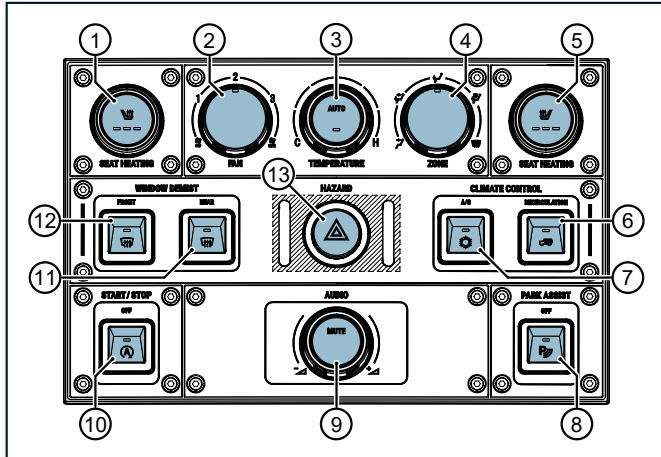

HEATED FRONT SEATS (OPTIONAL)



WARNING: Do not re-activate the heated seats directly after the auto timer has switched off the heated seats. Re-activating the heated seats repeatedly can cause the

seat to become very hot, and can cause burn injuries to persons with limited sensitivity to temperature changes.

Independently controlled heated front seats with three temperature settings for both the driver and passenger.

Press either or both buttons (1) and (5) on the centre console, to cycle the seat heating level on the front seats. The LEDs show which heating level is set, where the higher the number of LEDs illuminated, the greater the heating level.

FAN SPEED SETTING

Rotate the fan speed knob (2), on the centre console, clockwise to increase the fan speed and anti-clockwise to decrease the fan speed.

TEMPERATURE AND AUTO SETTING

Rotate the temperature knob (3), on the centre console, clockwise to increase the temperature and anti-clockwise to decrease the temperature.

Press the auto button once, to switch on the auto setting. The vehicle will maintain the same temperature by automatically increasing and decreasing the temperature of the air coming through the air vents.

CLIMATE CONTROL

AIR FLOW ZONES

Rotate the air flow zone knob (4), on the centre console, to select the preferred air vents to distribute air flow into the vehicle.

RECIRCULATION

Press button (6) on the centre console, to recirculate the air inside the vehicle.

AIR CONDITIONING

Press button (7) on the centre console, to switch on the air conditioning. This will activate the air conditioning to distribute cold air inside the vehicle.

WINDOW DEMIST REAR

Press button (11) on the centre console, to switch on the window demist rear feature. This will demist the rear window for clear visibility. Press a second time to switch off the window demist rear.

WINDOW DEMIST FRONT

Press button (12) on the centre console, to switch on the window demist front feature. This will demist the front window for clear visibility. Press a second time to switch off the window demist front.

VENT ADJUSTMENT

To Adjust the air vents, use the vent knob. Push up or down to adjust the blades inside the vent. Push left or right to adjust the angle of the vent unit. Rotate the knob to open or close the vent.

MAINTENANCE AND TECHNICAL INFORMATION

CAPACITIES AND TECHNICAL INFORMATION	168
SERVICE AND MAINTENANCE	171
FUEL	183
ELECTRICAL SYSTEMS	186
EXTERIOR CARE	195
INTERIOR CARE	199
HOSING THE INTERIOR	201
WHEELS AND TYRES	208
CUSTOMER INFORMATION	215

MAINTENANCE AND TECHNICAL INFORMATION

CAPACITIES AND TECHNICAL INFORMATION

Mass and Load

MASS AND LOAD	UTILITY 2-SEATER		UTILITY 5-SEATER		STATION WAGON	
	PETROL	DIESEL	PETROL	DIESEL	PETROL	DIESEL
Gross vehicle weight [kg]	3500	3500	3500	3500	3500	3500
Unladen weight (without driver) [kg]	2 629	2 704	2 665	2 740	2736 ^T - 2669 ^F	2811 ^T - 2744 ^F
Maximum payload (without driver) [kg]	871	796	835	760	764 ^T - 831 ^F	689 ^T - 756 ^F
Dynamic roof load (with roof rack) [kg]	150	150	150	150	150	150
Static roof load (with roof rack) [kg]	420	420	420	420	420	420
Maximum unbraked trailer mass (on-road) [kg]	750	750	750	750	750	750
Maximum braked trailer mass (on-road) [kg]	3500	3500	3500	3500	3500	3500
Maximum Trailer Nose Weight [kg]	350	350	350	350	350	350

MAINTENANCE AND TECHNICAL INFORMATION

MASS AND LOAD	UTILITY 2-SEATER		UTILITY 5-SEATER		STATION WAGON	
	PETROL	DIESEL	PETROL	DIESEL	PETROL	DIESEL
Gross train weight [kg]	7000	7000	7000	7000	7000	7000

^T Includes Trialmaster Edition specific options

^F Includes Fieldmaster Edition specific options

Volumes and Loadspace

Volume and Loadspace	UTILITY 2-SEATER		UTILITY 5-SEATER		STATION WAGON	
	PETROL	DIESEL	PETROL	DIESEL	PETROL	DIESEL
Maximum volume behind 1st row seat [Litre]	2088	2088	--	--	2035	2035
Maximum volume behind 2nd row seat [Litre]	--	--	1255	1255	1152	1152
Maximum luggage length behind 1st row seat [mm]	1512	1512	--	--	1645	1645

MAINTENANCE AND TECHNICAL INFORMATION

Volume and Loadspace	UTILITY 2-SEATER		UTILITY 5-SEATER		STATION WAGON	
	PETROL	DIESEL	PETROL	DIESEL	PETROL	DIESEL
Maximum luggage length behind 2nd row seat [mm]	--	--	890	890	799	799
Floor length behind 1st row seat [mm]	1687	1687	--	--	1795	1795
Floor length behind 2nd row seat [mm]	--	--	1062	1062	983	983
Loadspace width (floor between wheel-arches) [mm]	1064	1064	1064	1064	1064	1064
Maximum loadspace width [mm]	1268	1268	1268	1268	1268	1268
Lift in height [mm]	899	899	899	899	899	899
Loadspace height [mm]	1047	1047	1047	1047	1047	1047

MAINTENANCE AND TECHNICAL INFORMATION

Vehicle Dimensions

DIMENSIONS	VALUE
Length (without spare wheel) [mm]	4683 mm
Length (including spare wheel) [mm]	4895 mm
Width with mirrors [mm]	2146 mm
Width with mirrors folded [mm]	1930 mm
Height (kerb weight) [mm]	2050 mm
Track Width [mm]	1645 mm
Front Overhang [mm]	887 mm
Rear Overhang [mm]	874 mm
Wheelbase [mm]	2922 mm
Approach Angle (kerb weight) [°]	35.5°
Ramp Breakover Angle (kerb weight) [°]	28.2°
Departure Angle (kerb weight) [°]	36.1°
Ground Clearance (kerb weight) [mm]	264 mm
Wading Depth [mm]	800 mm

DIMENSIONS	VALUE
Wading Entrance Angle [°]	16°
Wading Departure Angle [°]	16°

SERVICE AND MAINTENANCE

General Information

Various systems on this vehicle are very sophisticated and complex, there is specialised equipment necessary to carry out service and maintenance on these vehicle systems, therefore owner maintenance should be restricted to the routine procedures described in this section.

Any servicing beyond what is described in this section should be carried out at the regular interval points by an INEOS approved partner. Any maintenance that is not described in this section will need to be carried out by an INEOS approved partner. If there is a malfunction with any of the systems included in this section, it is advised the vehicle is professionally inspected and repaired by an INEOS approved partner.

MAINTENANCE AND TECHNICAL INFORMATION

QR Code

It is important to keep the vehicle serviced and maintained. Follow the schedule provided to ensure the vehicle will run reliably, smoothly and efficiently. To see the service schedule, please scan the QR code below:



Parts and Lubricants

When servicing the vehicle, it is essential that only the recommended parts and correct fluid specifications are used. This will ensure the longevity of the vehicle's life and performance.



CAUTION: If oils and lubricants used do not meet the minimum guideline specifications, the vehicle may show signs of excessive wear and will require maintenance, if the damage caused is not detrimental. It is important that the correct oils and lubricants are used to avoid build up of deposits as this can cause considerable harm and damage to the environment with increased pollution.



CAUTION: If it evident to INEOS that the use of non-approved parts or products has caused damage to the vehicle or engine, then INEOS may refuse to authorise the repair of any damages arising from the use of those products under the terms of the manufacturers warranty.

Fuel System



WARNING: Do not allow the fuel levels in the fuel tank to reach empty. This will starve the engine of fuel and may damage the fuel system, e.g. the fuel pump(s).



WARNING: Modifications or additions to the fuel system, unless designed by INEOS, is prohibited. Be aware that any modifications or additions installed may be dangerous and can cause significant damage to the fuel system. All Service Action and Safety Recall Actions must be undertaken by an INEOS approved partner.

The Vehicle uses a complex and specialist electronic fuel injection system to give maximum reliability and performance with safe vehicle emissions. For these reasons, it is essential that the owner trusts the INEOS service team to carry out regular servicing and maintenance, at the required intervals or at a point of any malfunction.

MAINTENANCE AND TECHNICAL INFORMATION

Restraint System

INEOS recommend that the inflatable restraint systems (airbags) and seat belt components installed to this vehicle are replaced at ten year intervals from the date of manufacture on the certification label.

Servicing and Maintenance Safety Precautions

It is important, when carrying out any servicing tasks or maintenance tasks, that the following safety precautions are observed and followed:

 **WARNING:** When the vehicle is lifted with a lifting jack, do not work beneath or place objects under the vehicle, unless it is correctly supported by equipment designed to safely hold the vehicle in the air.

 **WARNING:** Always wear protective clothing and equipment where possible to ensure your own protection from dangerous or corrosive substances.

 **WARNING:** There are many moving parts that can cause harm. The cooling fan may still operate when the engine is not operating. Keep hair, hands, clothing and any other items such as jewellery and tooling clear of moving parts, such as, drive belts, pulleys and any other operating mechanisms. It is recommended that any clothing or jewellery that might cause harm when trapped or exposed to heat, such as, necklaces, rings,

bracelets or ties and loose clothing should be removed before working on the vehicle.



WARNING: When possible, work should be carried out when the engine is cold and at suitable temperature underneath. Catalytic converters, DPFs and GPFs radiate high temperatures, even after the engine and ignition has been switched off.



WARNING: Avoid skin contact with hot components such as the engine and exhaust system. It is paramount that skin contact is avoided when there are engine fluids or steam escaping areas of the vehicle. This indicates a malfunction and can cause fluids and steam to be unpredictable, hot and harmful.



WARNING: There are flammable and toxic substances in and around the vehicle engine bay, including underneath the vehicle. Flammable and toxic substances can be fluids or fumes in the air. For example, petrol is a highly flammable fluid that releases fumes into the air. Petrol fumes in a confined space can be highly explosive.



WARNING: In the event of a substance spillage, such as, petrol, switch the engine off. Do not use a flame or spark near fuel or fuel vapours. Do not smoke near fuel or fuel vapours.



WARNING: Ensure the area is well ventilated when the engine is operating. Harmful fumes will be produced.

MAINTENANCE AND TECHNICAL INFORMATION

Fumes and vapours can be colourless and odourless, causing unconsciousness and contributing to death.



WARNING: Keep children and pets clear of the vehicle when maintenance is undertaken. There should be no human, animal or any items inside the vehicle when maintenance is being carried out around or underneath the vehicle. Avoid added weight on the vehicle stands and any movement of the vehicle itself. Components and mechanisms unexpectedly moving can cause harm or death.



NOTE: Deviating from the prescribed INEOS service procedures or using non-approved parts could invalidate the warranty.

Engine Oils and Disposal Warnings



WARNING: Keep out of reach of children.



WARNING: Prolonged and repeated contact with used engine oils can cause serious skin disorders, including dermatitis and cancer. Avoid excessive contact, wash thoroughly after contact.



WARNING: When the oil is changed, be sure that it is done by an experienced person. In addition, observe all laws regarding the disposal of waste oil and toxic fluids.

It is illegal to pollute drains, water courses or soil with toxic chemicals, such as, used engine oil. Always dispose of vehicle liquids and lubricants at authorised waste disposal sites or at garage and refill stations. If in doubt, contact your local authorities for advice.

Environment Protection



WARNING: It is illegal to pollute drains, water courses, or soil. Use authorised waste disposal facilities, including civic amenity sites and garages providing facilities for receipt of used oil. If in doubt, contact your local authority for advice.

Dangerous Substances



WARNING: Keep out of reach of children. Some substances contain harmful chemicals and toxins, which can cause burning and blindness or even poisoning if consumed.



WARNING: Always read the instructions provided with any liquids, components or other substances whether that be printed on labels or stamped on the components and follow them carefully. Such instructions are included to protect your health and personal safety, never disregard them.

MAINTENANCE AND TECHNICAL INFORMATION



WARNING: Many liquids and other substances, used in motor vehicles are poisonous or hazardous and should under no circumstances be consumed. Liquids or substances, where possible, should not be in contact with the skin, eyes or mouth, it is important protective clothing and equipment is worn where possible, to avoid prolonged contact. Some of the substances to be aware of, include battery electrolyte, antifreeze, oil, brake fluid, petrol, windscreen washer additives, lubricants, refrigerant and various adhesives.

Emission Control

The vehicle is fitted with a variety of emissions equipment to meet specific market emission standards

You should be aware that the unauthorised replacement, modification or tampering with this equipment by an owner or repair shop, may be unlawful and subject to legal penalties.

In addition, engine settings must not be tampered with. These have been established to ensure that your vehicle complies with stringent exhaust emission regulations. Incorrect engine settings may adversely affect exhaust emissions, engine performance and fuel consumption, as well as causing high temperatures, which may result in damage to the catalytic converter (if fitted) and the vehicle.

Owner Maintenance Checks

INEOS recommend, the vehicle is taken to an INEOS approved partner for scheduled servicing and maintenance, to maximise the longevity of the vehicles life and to ensure the vehicle is safe for operation. However, it is also advised that the vehicle is checked regularly between scheduled services, prior to being operated in adverse terrain or weather conditions and before any long journey. Refer to the following pages for advice and check procedures.

Before operation Checks:

- > Walk around the vehicle to be sure there are no obstacles or objects, that could cause damage or obstruction to the vehicle.
- > Clear the windscreen and other windows of any obstructions, such as, frost for clear visibility.
- > It is also recommended, to visually check underside of the vehicle for signs of fluid leaks.
- > Check the tyres for signs of wear and deflation.
- > Check the operation of the lights, direction indicators, horn, washers and wipers.
- > Operation of seat belts and brakes.
- > Check there is a suitable amount of fuel to complete the intended journey or enough to get to a planned refueling station.

MAINTENANCE AND TECHNICAL INFORMATION

- > Position mirrors for clear vision around the vehicle and through your rear view mirror.

Weekly Checks:

- > Tyre Condition, such as, tread depth, foreign objects, cuts, and or abrasions to the side wall
- > Coolant Level
- > Brake fluid level
- > Power steering fluid
- > Power Steering Fluid Level
- > Windscreen washer fluid level
- > Check operation of windscreen washers
- > Air Conditioning Operation

Engine Oil



CAUTION: It is important to check the engine oil level regularly. Running the engine with low levels or high levels of engine oil, can cause serious engine damage.

Check the engine oil level every fourth fuel tank fill or weekly, whichever is the sooner.

Please see the 'Engine Oil Check and Refill' section for more information.

Bonnet Release

To open the bonnet, pull the lever located under the instrument panel, twice, to release the bonnet latch.



NOTE: Pull the bonnet opening lever twice, to ensure the latches have released inside the engine bay allowing the bonnet to be opened manually.

Open the bonnet and secure in place by using the bonnet stay. The bonnet stay can be placed in two locations, one for normal access and the second for service access.

To close the bonnet, lower the bonnet until near closed, then let the bonnet fall to close. If the bonnet does not shut, open the bonnet again and repeat with light hand pressure.

Washer Fluid level Check and Refill



WARNING: Only fill the washer fluid reservoir when the engine is cool and switched off. Never attempt to refill the screen wash reservoir when the engine is hot.



WARNING: Washer Fluid can be highly concentrated and can be extremely flammable. It could ignite if it comes into contact with hot materials such as the exhaust manifold or the engine block.

MAINTENANCE AND TECHNICAL INFORMATION



WARNING: INEOS recommend that a suitable funnel is used to avoid spillage, however clean any spillage around the filler opening before starting the engine.



WARNING: In the event of a fire in the engine compartment, close the bonnet immediately if possible and call the fire service from a safe distance.



NOTE: The rear washer system, uses the same reservoir as the front washer system. The reservoir is located inside the engine bay, inside the front, left hand side wing.

When refilling the washer fluid reservoir only use approved washer fluid to avoid unexpected damage and wear to any components such as the wiper blades. This will also help to avoid damage over a period of time with consistent use to areas such as paintwork and plastic materials.

Washer fluid might require different levels of dilution with water depending on the conditions, if it is cold with snow or frost then the solution used will be of a higher concentration to avoid freezing. Be sure to follow the information provided with the product and any instructions on the product before use.

Local or state regulations may restrict the use of volatile organic compounds (VOCs), which are commonly used as antifreeze agents in windscreen washer fluid. A windscreen washer fluid with limited VOC content should be used only if it provides adequate freeze resistance for all regions and climates in which the vehicle will be operated.

To Fill the washer fluid:

1. Remove the washer reservoir cap.
2. Position a clean suitable funnel into place.
3. Add the washer fluid.
4. Wipe any spillage.
5. Replace the cap until secure.

Engine Oil Check and Refill



WARNING: Engine oil or components, may be hot and could cause severe burns. Make sure the oil and components are given time to cool down before handling.



WARNING: Do not remove the oil filler cap when the engine is running. Hot oil will burn and cause harm.



CAUTION: Running the engine with low levels or high levels of oil can cause serious engine damage.



CAUTION: Failure to use engine oil that meets the required specification may cause excessive engine wear, a build up of sludge and deposits, and increased pollution. It could also lead to engine failure.



CAUTION: This vehicle's warranty may be invalidated if damage is caused by the use of incorrect engine oil. Low

MAINTENANCE AND TECHNICAL INFORMATION

quality or obsolete oils, do not give the protection required by modern engines.



CAUTION: Operating materials are hazardous and could be poisonous. Handle with care. Pay attention to information given on the containers.



CAUTION: The levels should only be between minimum and maximum never over maximum or under minimum. Contact an INEOS approved partner, if the oil level is below minimum or above maximum between services intervals.



NOTE: It is recommended when adding oil to use a suitable clean funnel is used to avoid spillage. Spillage of oil can be dangerous if spilled onto hot components such as the exhaust as oil can ignite. If there is a fire in the engine bay compartment close the bonnet and call the fire service from a suitable and safe distance.

The oil level in the engine is electronically monitored, the driver is alerted when the oil level is getting low and requires topping up. Avoid regularly driving the vehicle if the oil level is low, if the oil level is low, and the low oil warning system continues to alert the driver after topping up, there could be fault. If this happens, immediately consult with your nearest INEOS approved partner and avoid driving the vehicle until resolved.



WARNING: The Diesel B57 engine does have a dipstick in the engine bay, however this must NOT be used to check engine oil level.

The oil level for both Petrol and Diesel engines are monitored electronically. The driver can view the oil level within the vehicle information using the infotainment screen. The oil level will be shown to the driver using the following values:

OIL LEVEL	VALUE SHOWN
Motor oil level at a minimum	MIN
Level 1	25 %
Level 2	50 %
Level 3	75 %
Motor oil level full	100 %
Motor oil level overfilled	SPILL
Motor oil level OK	OK
Service function active	FUNC

To add oil to the engine follow the procedure:

1. Locate the oil cap in the engine bay.
2. Turn the cap counter-clockwise and remove it.

MAINTENANCE AND TECHNICAL INFORMATION

3. Add the INEOS approved engine oil.
4. Replace the cap and tighten clockwise, do this until there is a resistance and the cap is secured.
5. Now check the engine oil level again to ensure the correct level of oil is achieved.



NOTE: The capacity difference between minimum and maximum fill levels is approximately one litre of oil.

PETROL B58	SERVICE FILL
Volume @ 15 °C	6,5 L
Engine Oil	0W20
Recommended Engine Oil	Titan EM BMW 4615E-0W

DIESEL B57	SERVICE FILL
Volume @ 15 °C	7,5 L
Engine Oil	0/5W30
Recommended Engine Oil	Petronas Syntium 0W30 DG

Engine Oil Viscosity Grades

The Society of Automotive Engineers (SAE) viscosity grade gives information for the thickness of the oil. Multi-grade oil is indicated by two figures, e.g. SAE 5W-30. The first figure, followed by a W, indicates the low temperature viscosity determined by the oil's flow at 0 degrees Fahrenheit or -17.8 degrees Celsius. The 'W' stands for winter, so the lower the number before the 'W' the less it thickens in cold temperatures. The second figure is the high temperature viscosity, this is determined by the oil's flow measured at 212 degrees Fahrenheit or 100 degrees Celsius, this number represents the oil's resistance to thinning at high temperatures. It is essential to select the appropriate viscosity grade oil depending on the minimum ambient temperature. All of the recommended viscosity grades are suitable for high ambient temperatures.

Engine Coolant Check and Refill



WARNING: Operating materials are hazardous and could be poisonous. Handle with care. Pay attention to information given on the containers.



WARNING: Do not remove the filler (pressure) cap until the coolant system has cooled down. Scalding can be caused by escaping steam or/and coolant.



NOTE: When removing the coolant fluid cap it is advised to use a cloth or heat and liquid proof gloves to protect hands and arms adequately.

MAINTENANCE AND TECHNICAL INFORMATION

There are two reservoirs, the main coolant reservoir for high temperature components and the auxiliary reservoir for low temperature components. Both reservoirs work independently, however if one is using more coolant than the other and needs topping up more frequently this could be a sign of malfunction and should be seen by an INEOS approved partner.

The high temperature reservoir and the auxiliary low temperature circuit reservoir are located in the engine bay, the high temperature reservoir being the larger of the two.

1. Remove the coolant cap by rotating anti-clockwise, until the cap is removed. To check the levels of fluid notice there is a low and maximum level indicator visible on the inside of the tank itself.
2. Add the correct specified coolant fluid to the reservoir, until the level reaches the maximum marker. It is important not to overfill the reservoir above the maximum or leave the coolant level below minimum.
3. Once appropriately filled re-apply the coolant cap by rotating clockwise until tight.



NOTE: Over tightening the cap can damage the thread on the bottle and the cap itself.

Diesel Water Separator (OPTIONAL)



WARNING: Take care to not splash any water or fuel onto the face, in particular the eyes and mouth. Immediately wash liquid from the face safely and seek medical advice.



WARNING: The vehicle must be switched off completely before unplugging the electrical connector to access the drainage plug.



WARNING: Make sure the vehicle has been switched off and the car has cooled down until cold. Failure to do this can result in burns to the body from hot liquid or by touching components, such as, the exhaust pipes under the vehicle.



CAUTION: Do not pull on the wiring when releasing the electrical plug from the water separator. This can damage the electrical plug, consult with an INEOS approved partner if this happens.

Drain the water separator before driving and after driving off road. This ensures that the water separator does not fill and trigger any warning lamps or messages on the centre console screen.

MAINTENANCE AND TECHNICAL INFORMATION

Water separator draining procedure:

1. Remove the electrical plug from the underside of the water separator.
2. Put an empty reservoir under the water separator.
3. Open and remove the draining plug. Take care when removing the drainage plug, as water and some fuel may immediately spill from inside the water separator.
4. Allow the water separator time to completely drain of water and fuel.
5. Close the water separator by re-assembling the drainage plug to the water separator.
6. Plug the electrical connector back into place.



NOTE: The drained liquid may contain fuel, it is essential that the liquid is disposed of safely in an environmentally friendly location.



NOTE: Take care that no fuel goes onto the ground.

Brake Fluid



WARNING: Do not drive the vehicle if the brake fluid is below the minimum mark



WARNING: Operating materials are hazardous and could be poisonous. Handle with care. Pay close attention to information given on the containers.



WARNING: Wear protective clothing such as gloves when using corrosive substances to protect the hands and arms.



CAUTION: Brake fluid is very corrosive. If there is a spillage then the area should be cleaned straight away with clean water and a clean damp cloth. If left the fluid can damage and remove paint or eat into metals.



CAUTION: Do not apply the brakes suddenly or intermittently after a the brake system has been serviced. This includes, but not limited to, brake pad, brake disc replacements and/or brake fluid replacement. If you do, the performance and life of the brake pads and discs can be negatively affected.

The brake fluid reservoir will have a minimum and maximum level indicator or marking. The fluid level should be between the minimum and maximum markings, never below minimum or above maximum. If the fluid is below the minimum mark, a warning message will appear and the brake tell-tale lamp will illuminate. To top up the brake fluid:

1. Remove the Reservoir cap.
2. Fill brake fluid up to the maximum level.
3. Install the reservoir cap securely.

MAINTENANCE AND TECHNICAL INFORMATION



NOTE: If the brake system has been serviced or the pads and/or discs have been replaced, make sure that you apply the brakes carefully and gradually for 300 miles (500km) to complete the bedding in process.

Brake Pad Wear Indication



WARNING: If there is a brake warning lamp illuminated, immediately consult with an INEOS approved partner. Continuing to drive the vehicle can result in further damage to the vehicle, or even a crash resulting in injury or even death.



CAUTION: If the brake wear sensor has been activated and the brake pads need replacing, contact an INEOS approved partner immediately to have the brake system checked and the pads replaced.



CAUTION: Do not apply the brakes suddenly or intermittently after a the brake system has been serviced. This includes, but not limited to, brake pad, brake disc replacements and/or brake fluid replacement. If you do, the performance and life of the brake pads and discs can be negatively affected.



CAUTION: If the brake system has been serviced or the pads and/or discs have been replaced, make sure that you apply the brakes carefully and gradually for 300 miles (500km) to complete the bedding in process.



CAUTION: If you suspect that there is an issue with the brake system, the pads may be at a low level or there is uneven pad wear, please consult immediately with your nearest INEOS approved partner.

The brake pad wear sensor warns the driver when the brake pad wear exceeds a tolerable limit. The brake tell-tale lamp  will illuminate to signal to the driver that there may be a malfunction and/or the brake pads have been reduced to a critical level.

Checking Wiper Blade Condition

Check the condition of your window wiper blades by looking for fraying rubber, or any other damage, such as, cracks in the rubber. Also, check how well your wipers clear water from the windscreen. If there are smear marks or water residue remaining, you will need new wiper blades.

The window wiper swivel arm or frame, can also be bent or damaged resulting in the need for window wiper replacement. A bent window wiper can sometimes be the cause of sounds, such as, squeaking and chattering when in operation.

Replacing Wiper Blades



WARNING: When removing the blade from the swivel arm, INEOS recommend that windscreen protection is used to avoid accidental damage.

MAINTENANCE AND TECHNICAL INFORMATION

To replace a windscreen or rear screen wiper blade, make sure a protection mat is used to avoid accidental damage. First, lift the wiper arm away from the windscreen or rear window, press the retaining clip and push the blade away from the arm. As you are pushing away from the arm, unhook the wiper blade.

Locate the new blade assembly on the arm, hook it to the swivel bracket and push in to engage until the blade is retained by the clip, remove the protection mat.

Always fit wiper blades that are identical to the original specification.



NOTE: INEOS recommends, the vehicle is taken to an INEOS approved partner to have the window wipers replaced as necessary, but they will also be checked during each service for any defects or signs of wear. It is also recommended, that the vehicle is transported to the INEOS approved partner in good weather to avoid driving in hazardous conditions, without full functionality of the window wipers.

Headlight Unit

The headlight unit is sealed to give superior protection when driving in extreme conditions. The headlight unit consists of the headlight, side light and directional indicator signal lamps. The headlight unit is designed to last and withstand extreme conditions including driving in hot and cold weather or while wading through high water levels.

If the headlight unit has a malfunction, there will be a warning message and a tell tale lamp symbol illuminated to warn the occupants of the malfunction.

If a headlight unit malfunctions, visit an INEOS approved partner to have the issue investigated, and/or a replacement unit installed and the functionality of the headlight unit restored to the vehicle.

FUEL



CAUTION: It is essential to use the correct fuel in the vehicle. If you do not use the correct fuel, then you could damage the fuel system and the engine.



CAUTION: Do not use E85 fuels in the vehicle. Using E85, may cause damage to the fuel system. If E85 fuel is put into the tank, consult your nearest INEOS approved partner immediately.

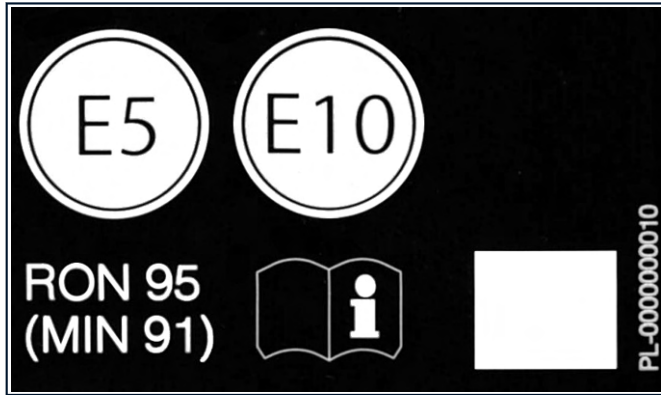

MAINTENANCE AND TECHNICAL INFORMATION

The recommended fuel for the petrol engine is 95 RON unleaded, but a minimum of 91 RON unleaded can be used.

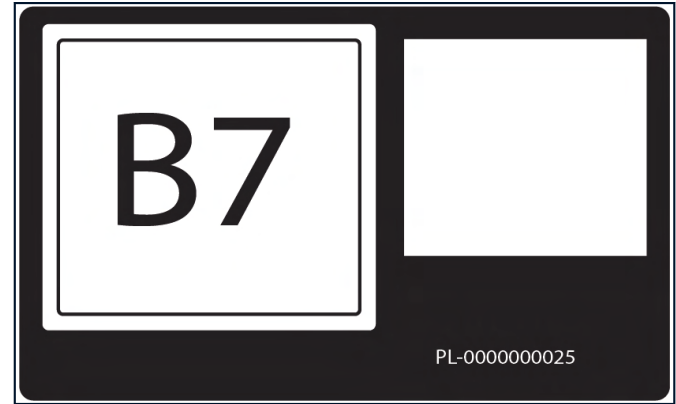

The recommended fuel for the diesel engine is B7. Use Diesel that meets the specification defined by EN 590, or the relevant national specification.



-  *NOTE: Unleaded petrol, meeting specification EN228, with a maximum ethanol content of 5% or 10% may be used.*
-  *NOTE: Diesel fuel, meeting specification EN590, with a maximum bio-diesel content of 7% may be used.*

MAINTENANCE AND TECHNICAL INFORMATION

Fuel Safety



WARNING: Do not create a spark, flame or heat near a fuel. There is a risk of fire or explosion leading to serious injury or even death.

Fuel Economy

It is essential to maximise the fuel economy of the vehicle. To do this, the following points must be considered before driving your vehicle.

- > Acceleration.
- > Speed.
- > Braking.
- > Regular maintenance.
- > Weather.
- > Start/stop short journeys.
- > Terrain.
- > Four wheel drive.
- > Luggage and towing.
- > Running electrical accessories and features.

To maximise fuel economy, it is essential to accelerate gently and to keep speed to the limits of the roads used. Fast acceleration

and speeding creates wind resistance, therefore, using more fuel to keep the vehicle accelerating and maintaining high speeds. Heavy and sudden braking can reduce fuel efficiency, take care to brake gently and earlier to improve the fuel economy of the vehicle.

It is important to maintain the vehicle, servicing the vehicle regularly will help keep the vehicle economical. The following points will decrease the vehicles economical performance, if not correct:

- > Tyre pressure.
- > Wheel alignment.
- > Oil condition.
- > Air filter Condition.
- > Fuel filter condition.

Cold weather and short trips will impact the economy performance as the engine will take time to warm up to the optimal running temperature. Driving on uneven surfaces or in the rain, on wet roads can impact the economy of the vehicle as this will add resistance to the vehicle when in motion.

Driving with heavy luggage in the vehicle, on the roof racks or when towing a trailer can impact the fuel efficiency.

Running electrical accessories and features, such as, the air conditioning when placed on 'MAX' decreases the fuel economy.

MAINTENANCE AND TECHNICAL INFORMATION

Fuel Tank and AdBlue Capacity

FUEL/LIQUID	FUEL CAPACITY
Petrol	90 L
Diesel	90 L
AdBlue	17 L

ELECTRICAL SYSTEMS

BATTERY

Vehicle Battery: 12v105Ah EFB H9

The vehicle battery is maintenance free and should only require checking by your INEOS approved partner during regular vehicle service intervals.

Battery Information



WARNING: Always wear protective clothing, such as, gloves and arm coverings when handling batteries. Failure to do so can result in injury.



WARNING: Keep batteries out of reach of children.



WARNING: Batteries contain sulphuric acid. Avoid contact with skin, eyes or clothing. Shield your eyes when working near the battery to protect against possible splashing of acid solution. In case of acid contact with skin or eyes, flush immediately with water for a minimum of 15 minutes and get prompt medical attention. If acid is swallowed, get medical help immediately.



WARNING: When lifting a plastic cased battery, excessive pressure on the end walls could cause acid to flow through the vent caps, resulting in personal injury, damage to the vehicle or battery. Lift the battery with a battery carrier or with your hands on opposite corners.



WARNING: Never place metal objects on the battery or allow the positive terminal of the battery to contact parts of the vehicle body. This can create a spark or a short circuit which can ignite gases created when the battery is charged.



WARNING: Electrostatic charge can cause sparks, which may ignite the highly flammable gas mixture within the battery.



WARNING: Keep the battery away from flames, sparks, or lighted substances. Batteries normally produce

MAINTENANCE AND TECHNICAL INFORMATION

explosive gases when charging or when jump started. Always have sufficient ventilation.



WARNING: Be sure to wear gloves when handling battery posts, terminals and related accessories as they contain lead compounds. Even after wearing gloves make sure you wash your hands after handling.



CAUTION: The engine must never be run with the vehicle battery disconnected. This can cause damage to vehicle electrical modules.



CAUTION: Apart from vehicle recovery, this vehicle must not be driven if the vehicle battery is incapable of starting the engine. In this case the vehicle battery must be replaced. Contact your INEOS approved partner.



CAUTION: INEOS do not recommend replacing the Lead-Acid starter battery with an LFP (LiFePO₄) battery.

Changing the Battery



CAUTION: INEOS do not recommend replacing the Lead-Acid starter battery with an LFP (LiFePO₄) battery.



NOTE: INEOS recommends that you have the 12v battery replaced by an INEOS approved partner. If you want to

change the battery yourself, then you must observe the following notes first:

- > *Only replace the battery with one that is exactly the same specifications, meeting the correct requirements.*
- > *Carry over detachable parts, such as vent hoses, elbow fittings or terminal covers from the battery being replaced.*
- > *Make sure the vent hose is always connected to the original opening on the battery.*
- > *Install any existing or supplied cell caps.*
- > *Make sure that detachable parts are reconnected in the same way before they were removed.*

Battery Level Protection



CAUTION: If the battery is not capable of starting the engine, replace the battery as soon as possible.

The vehicle is fitted with an Intelligent Battery Sensor (IBS), this monitors battery voltage and current, along with the battery acid temperature. If the battery capacity is critically low, the sensor informs the ECU resulting in a warning message being displayed on the infotainment screen to notify the occupants. If a low battery warning message shows, start the engine and allow to idle so that the battery can recharge, or connect a suitable battery

MAINTENANCE AND TECHNICAL INFORMATION

charger or conditioner. Alternatively drive the vehicle for at least thirty minutes to replenish the battery charge levels. It is recommended, that if the battery capacity reaches a critical point, you contact an INEOS approved partner for a battery health check.

Battery Disposal



WARNING: Improper disposal of batteries could cause serious injury.



WARNING: Do not dispose of a battery in fire or water.



NOTE: Environmental damage is caused by improper disposal of batteries.



NOTE: Do not dispose of batteries with your household rubbish as this is illegal.

Batteries contain pollutants and can be hazardous to your health and the environment. Most batteries contain materials that, when disposed of incorrectly, may leak into the environment. This can contribute to soil and water pollution and endanger wildlife.

Dispose of batteries in an environmentally responsible manner and follow your local authorised standards for disposal. Call your local authorised recycling center to find out more about recycling automotive batteries.



NOTE: If you have to disconnect the 12v battery, INEOS recommends you contact an INEOS approved partner for support.

Auxiliary Battery (OPTIONAL)



WARNING: If water enters the battery and fuse compartments, do not attempt to touch the components and seek further advice from your INEOS approved partner. Failure to do so may result in serious injury or death.

The Auxiliary Battery is connected to the vehicle's electrical system but isolated from the starter circuit. The Auxiliary Battery is used as a safety back-up to support the main battery when required or to provide voltage for specific vehicle systems.

The Auxiliary Battery protects the vehicle as it prevents a voltage drop when cranking the engine.

Auxiliary Switch Panel and Electrical Preparation



WARNING: Do not attempt to modify the wiring harness. If components are damaged and or need replacing please seek further advice from your INEOS approved partner. Failure to do so may result in serious injury or death.

MAINTENANCE AND TECHNICAL INFORMATION

 **WARNING:** Do not splash any electrical wires or connectors. If any electrical wires or connectors are exposed to moisture, they might corrode and break or result in a system failure.

 **CAUTION:** Always check the electrical accessories power requirements and consult the accessory manual before connecting to the vehicles power supply.

The vehicle comes with three pre-wired 10A electrical outlets, one in both the driver and front passenger foot-well, and one located under the bonnet.

High Load Auxiliary Switch Panel and Electrical Preparation (OPTIONAL)

 **CAUTION:** When connecting electrical accessories to the auxiliary outlets ensure the connection is free of dirt, debris and moisture, failure to do so will result in poor conductivity.

The High Load Auxiliary Switch Panel & Electrical Preparation includes an additional 25A outlet under the bonnet, 25A outlet at the rear of the vehicle and four outlets located in the roof-rail recesses. The four roof outlets run on two circuits, outlet A on circuit one and outlets B, C and D on circuit two. Each circuit has a 25A maximum capacity.

Front 12V Socket

One 12V socket comes as standard in the front of the vehicle, located in the central storage tray.

FUSES

 **WARNING:** If a fuse blows after replacement, do not use the electronic component associated with that fuse. Failure to do this will risk a fire in the vehicle, leading to vehicle damage, injury and even death.

 **CAUTION:** Only replace a fuse with another fuse of the same rating and type. Failure to do this can result in electrical component damage.

The vehicle and the electrical components on the vehicle, are protected from electrical surges. Fuses are installed to the vehicle to prevent damage to electrical circuits. If too much current is supplied to a fused circuit, the fuse will blow, breaking the circuit. This reduces the risk of damage to any other electrical systems and components on the vehicle.

The element within a fuse will break or melt, signaling that there has been an electronic surge. Change the fuse or have an INEOS approved partner change the fuse for you. If the same fuse blows again, consult your INEOS approved partner, as soon as possible.

The following image shows the locations of the different fuses inside the Interior Electrical Centre fuse box. The table explains the location, relevant system(s) and amp rating of each fuse.

MAINTENANCE AND TECHNICAL INFORMATION

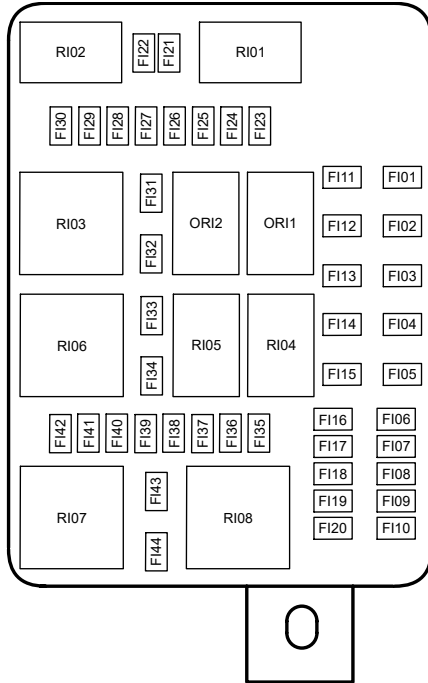

FUSE POSITION	DESCRIPTION	AMPERAGE
FI01	IGN Relay (CL15 - Electronics)	30
FI02	IGN Relay (CL15 - Pumps / Heating)	60
FI03	Front Wiper Motor	30
FI04	Accessory Relay (CL30ACC - R103)	60
FI05	Horn (BCM)	20
FI06	Window Lifter FL (BCM)	30
FI07	Window Lifter FR (BCM)	30
FI08	Window Lifter RL (BCM)	30
FI09	Window Lifter RR (BCM)	30
FI10	After Run Relay (CL30S - R102)	25
FI11	Rear Defog	30
FI12	HVAC (Blower)	40
FI13	Spare (Air Compressor / Dust Gun)	40
FI14	Trailer Module	40

MAINTENANCE AND TECHNICAL INFORMATION

FUSE POSITION	DESCRIPTION	AMPERAGE
FI15	SCR Module 1	30
FI16	Gateway Module 1 (ETGW)	30
FI17	Water Separator	25
FI18	Fuel Pump	30
FI19	Gateway Module 2 (ETGW)	15
FI20	Door Lock	20
FI21	Seat Heating Right	25
FI22	Seat Heating Left	25
FI23	Cooling Fan / AC Compressor	5
FI24	Gear Shifter	5
FI25	Cluster / Interior Lighting / Steering Wheel	5
FI26	SCR Module 2	15
FI27	Brake Light Switch	5
FI28	Overhead Console Switch	10
FI29	LHS Foot-well	10

FUSE POSITION	DESCRIPTION	AMPERAGE
FI30	RHS Foot-well	10
FI31	Trailer	25
FI32	Heated Mirrors	7.5
FI33	Trunk Lamp / IBS / NVLD	5
FI34	Reserved (ADAS)	FREE
FI35	Run Crank - Steering / ESC / Brake Fluid Sensor	7.5
FI36	Airbag Control Module	10
FI37	Run Crank - BCM / ETGW / Seat Mat / Park Assist / Rear View Camera / E-Call	7.5
FI38	Power Mirrors	5
FI39	Headlamp Levelling	10
FI40	Run Crank - HVAC / Cluster / Steering	7.5
FI41	Fuel Pump Controller / Exhaust Flap / Water Separator	5
FI42	Front Wiper / Rear Wiper	15

MAINTENANCE AND TECHNICAL INFORMATION

FUSE POSITION	DESCRIPTION	AMPERAGE
FI43	Water Pump	10
FI44	Water Pump (Diesel Only)	10

The following image shows the locations of the different fuses inside the Under-hood Electrical Centre fuse box. The table explains the location, relevant system(s) and amp rating of each fuse.

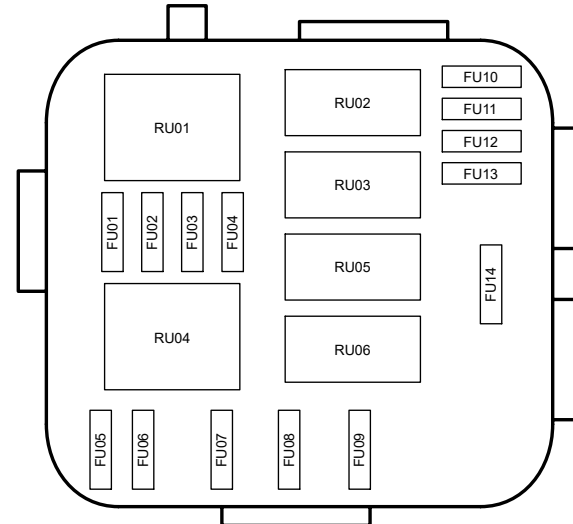

MAINTENANCE AND TECHNICAL INFORMATION

FUSE POSITION	DESCRIPTION	AMPERAGE
FU01	Reserved	FREE
FU02	Transmission	20
FU03	Reserved	FREE
FU04	A/C Compressor	10
FU05	Gateway Module (ETGW)	5
FU06	Engine Cooling Fan	15
FU07	Electronic Stability Control (Valves)	40
FU08	Washer Pump	30
FU09	Starter Motor	30
FU10	Reserved	FREE
FU11	Reserved	FREE
FU12	Reserved	FREE
FU13	Horn - Toot	7.5
FU14	Electronic Stability Control (Motor)	60

The following image shows the locations of the different fuses inside the Cockpit Electrical Centre fuse box. The table explains the location, relevant system(s) and amp rating of each fuse.

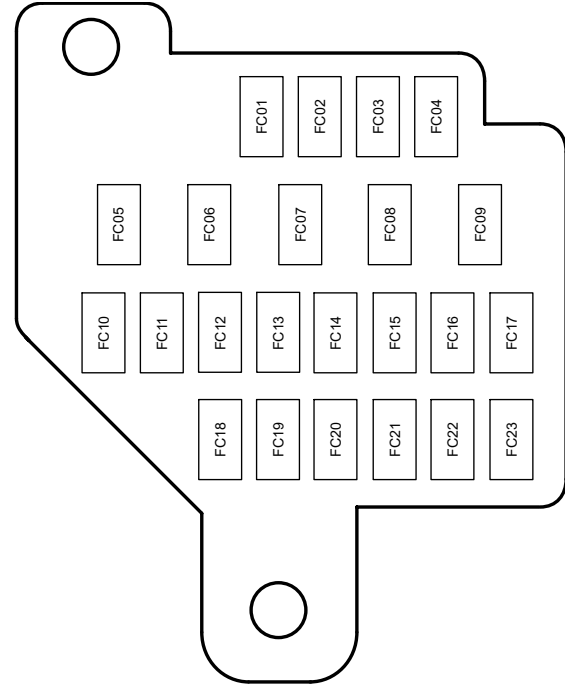

MAINTENANCE AND TECHNICAL INFORMATION

FUSE POSITION	DESCRIPTION	AMPERAGE
FC01	Reserved	FREE
FC02	Reserved	FREE
FC03	HVAC Module	7.5
FC04	Clock / Theft Alarm / Logistics	5
FC05	Body Control Module 1	40
FC06	Body Control Module 2	30
FC07	Additional Heater Step 3	40
FC08	Additional Heater Step 2	40
FC09	Additional Heater Step 1	40
FC10	Reserved	FREE
FC11	HVAC Module	7.5
FC12	Head Unit	20
FC13	Emergency Call	5
FC14	Ignition Switch / Steering Wheel	10
FC15	Onboard Diagnostics (OBD-II)	10

FUSE POSITION	DESCRIPTION	AMPERAGE
FC16	Reserved	FREE
FC17	Reserved	FREE
FC18	Reserved (Diagnostics)	FREE
FC19	Reserved	FREE
FC20	Reserved	FREE
FC21	12V Front Outlet	15
FC22	USB Charging	5
FC23	12V Rear Outlet	15

The amp rating of fuses is denoted by colours to help identify the maximum current capacity of a fuse. The following table explains the fuse colours and the amp rating they signify.

FUSE	CURRENT RATING
Black	1A
Grey	2A
Violet	3A

MAINTENANCE AND TECHNICAL INFORMATION

FUSE	CURRENT RATING
Pink	4A
Tan	5A
Brown	7.5A
Red	10A
Blue	15A
Yellow	20A
Clear	25A
Green	30A
Aqua Blue	35A
Orange	40A
Red	50A
Blue	60A
Tan	70A
Clear	80A

EXTERIOR CARE

Washing



WARNING: Only wash the vehicle when the vehicle has cooled down and make sure the panels are also cool.



WARNING: Do not use hot water, only use cold or lukewarm water.



CAUTION: The use of high power pressure cleaners can penetrate window seals and doors. Do not aim the pressure washer blast directly at any components that might be penetrated or damaged.



WARNING: Use of high pressure cleaners could cause damage to the paintwork and other exterior fittings.



CAUTION: Make sure the heater blower is set to off to prevent any damage or contamination of the fresh air filter

It is essential to wash the vehicle to maintain the condition of the body panels and underside of the vehicle, including the inner wheel arches and wheels.

It is particularly important to wash the vehicle frequently in the winter months when the roads have been treated with salt, this will require the washing of the underside, including the inner

MAINTENANCE AND TECHNICAL INFORMATION

wheel arch areas to wash clear harmful contaminants that might lead to corrosion or further damage of components.

Frequent washing is also advised when using the vehicle off-road or when wading in muddy, sandy or salt water conditions. Pay particular attention to the underside and lower bodywork of the vehicle including the wheel areas to ensure any harmful contaminants are washed away from the vehicle.



NOTE: When washing the brake caliper and disc, it is advised to drive the vehicle for a short period of time immediately after washing is complete. This is to avoid any corrosion developing and to ensure that any water or cleaning products, have dried off and removed from the brake systems and components.



NOTE: A thin layer of oxidised material may form on the brake discs if left to dry without driving the vehicle. This is normal and should not affect performance of the brakes.

INEOS advises the following, when washing the vehicle:

- > Do not use household soaps or detergents.
- > Do not direct water hoses or pressure washers at full force around the doors, bonnet and Safari Window seals (if applicable) to help avoid seal failure.
- > Do not use a brush on the vehicle body as this will scratch the paintwork and lamp lenses.
- > Do not wash the vehicle in direct sunlight.

- > Let the vehicle cool before washing.

Suggested Washing Method:

1. Pressure wash or hose down the vehicle removing any clumps or mud, debris or road dust.
2. Add mild neutral detergent to a bucket of water, following the detergent manufacturers instructions.
3. Fill a second bucket of water to be used as the rinse bucket.
4. Use a large clean wash mitt, soak in the bucket of detergent mixed with water and apply to the vehicle. Make sure to wash the vehicle in small sections starting from the top working your way down.
5. Rinse the wash mitt frequently in the bucket of plain rinse water to avoid a build up of mud and grit in the mitt as this can cause damage to the paint work.
6. It is recommended if the vehicle has been used for off-roading or wading to go around the vehicle in full several times. For extremely dirty vehicles, with a lot of mud and dust, it is recommended that each section or panel is hosed down after washing with the mitt to ensure any remaining contaminants are washed off the paint work.
7. It is important to always keep the vehicle wet and to never let any detergent water dry on the vehicle as this can leave staining and water marks.

MAINTENANCE AND TECHNICAL INFORMATION

- Once finished, using a pressure washer or hose rinse the vehicle down fully to ensure the full vehicle is clean and no dirty water is trapped around the vehicle bodywork. This is also good to check that no sections have been missed.
- Lastly dry the vehicle with a soft drying towel before allowing to air dry to avoid water spots appearing on the vehicle.

Glass and Mirror



CAUTION: Do not scrape the inside of the rear window or use abrasives or chemical solvents to clean it. This will cause damage to the heating elements.

After washing the vehicle, using a soft, lint free cloth wipe and clean the windows of the vehicle, use a window cleaner designed for vehicle use, but follow the instructions of the manufacturer carefully.

Do not use abrasive cleaning compounds or scrapers to clean the mirrors in and around the vehicle as they are susceptible to damage, if care is not taken.

Paint Work



WARNING: Any vinyl or stickers applied to the vehicle may result in damage to the paintwork.



WARNING: Any paint work repairs other than touching in small minor stone chips should be carried out by an INEOS approved partner.

Modern water based paints are more susceptible to contamination and marking by corrosive substances, however they are much safer and more environmentally friendly than solvent based paints.

The most common contaminants which may adversely affect your paint work are listed below:

- > Bird droppings
- > Insect remains
- > Oil and Greases
- > Brake Fluid
- > Tree sap and pollen
- > Antifreeze
- > Resin
- > Tar
- > Salt.



NOTE: The list of contaminants may be added to over time as this list is not exhaustive of the contaminant groups that might adversely effect the paint work.

MAINTENANCE AND TECHNICAL INFORMATION

Wash any of the listed contaminants off the vehicle immediately, use warm water and vehicle shampoo where possible. During the warmer summer months it is particularly important to wash any contaminants off the vehicle at the earliest opportunity to avoid the sunny weather from accelerating any contamination effects on the paint work.

Minor paintwork damage such as minor stone chips can be touched up using a touch-up pen before rust forms and leads to corrosion.



WARNING: Any paint work damage repairs should be carried out by a qualified body shop professional. Contact your nearest INEOS approved body repair center for further advice.

Road Wheels

The wheels, wheel nuts and center trims, should be cleaned regularly to avoid build up of dust, mud and salts from road use, off-roading and wading. Use a pH- neutral wheel cleaner or a mild soapy water solution to avoid damaging the wheel or wheel paint and coatings. When washing the wheels make sure any solution used does not dry fully before rinsing off with clean water.

Headlamp Lenses

Clean the headlamps using a soft cloth and mild soapy water. Do not use any cleaning products containing solvents, abrasives or caustic agents. Do not clean the headlamp lenses using a dry

cloth, always use mild soapy water and do not use a scraper to avoid scratching of the lens.



NOTE: Always clean the headlamps after off-roading and wading for maximum lighting in all conditions. Failure to do this can result in an incident or crash.

Under Bonnet Cleaning

Under bonnet cleaning should be done with engine bay cleaner, always follow the instructions of the engine bay cleaner carefully to avoid damaging any plastics or metals. Do not use high pressure hoses or steam cleaners to clean the engine bay to avoid water entering the electronic control module or fuse boxes.

Polishing and Waxing

Wax the vehicle regularly to protect the paintwork when off-roading or wading. Some polishing products might be designed with silicone to leave a temporary protective layer, read the manufacturers instructions to determine if wax also needs to be applied. Polishing the vehicle will remove light swirling or marking from harsh environments, but a wax or sealant should be applied to add a protective layer to the paintwork. If the vehicle is waxed and sealed, water will bead off the vehicle when driven in the rain or after short periods of wading. Apply products as instructed by the manufacturers instructions label.



NOTE: Do not treat plastic trims and parts with the polish or wax, this might discolour and damage the parts.

Underride Protection



CAUTION: Heavy off-road use only permitted with adequate fuel tank protection (Heavy underride protection).

The vehicle underbody has sacrificial protective panels to protect the radiator, fuel tank and exhaust system from being damaged or corroded by exposure to salt, grit, mud and water. Consult your INEOS partner for inspection and repair as necessary, especially after sustained off-road or wading use.



NOTE: Any underbody protection work carried out, should be done by a INEOS approved workshop. Before and after winter or sustained off-roading and wading, wash the underbody and have the protective panels checked.

Body Maintenance

After washing, inspect the body of the vehicle for any signs of damage, such as, stone chips and scratches. Touch up any minor damage with a touch in pen to help slow corrosion and contact your nearest INEOS approved partner for further advice.



NOTE: It is recommended to check the bodywork before and after driving off-road and wading, this is particularly important if you are planning on driving the vehicle on the road straight after off-roading or wading.

INTERIOR CARE

Upholstery and Carpets



WARNING: Solvents and fumes from cleaning products may be dangerous in confined spaces. Make sure that the vehicle is well ventilated and follow the manufacturers printed instructions when using these products.



WARNING: Do not use petrol, furniture creams or household polishes to clean any of the interior.



CAUTION: Certain types of clothing, such as denim and vegetable tanned leather, are prone to 'dye transfer'. This can cause discolouration in the leather. Make sure that the affected areas are cleaned and re-protected as soon as possible.



CAUTION: Be careful when cleaning the interior that any clothing worn does not damage the seating fabric or leather and does not damage or scratch any of the interior surfaces. Velcro might damage the fabric interior and any clothing with sharp edging such as zip fasteners or belt buckles may tear fabrics, scratch and mark leather or may also result in the possibility of scratching plastic interior surfaces.

MAINTENANCE AND TECHNICAL INFORMATION



CAUTION: Do not use water to clean the dashboard, buttons, switches, LCD screens or any other electrical components as damage to the fuses and switches could occur. It is advised to use a mildly damp cloth instead or an interior cleaning product. Follow the manufacturers instructions label very carefully when using interior cleaning products, never spray products directly onto the dashboard or buttons, but spray a soft lint free cloth instead.

Only clean the vehicle interior with a mildly damp cloth or a approved interior upholstery cleaning product and follow the manufacturers instructions label carefully.

Clean the leather upholstery with clean water and a soft cloth, use leather cleaner products for heavy soiled leather. Follow the manufacturers instructions label carefully. It is advised to regularly gently brush the leather seats with a very soft hand brush to remove any dust or dirt that is dry.



CAUTION: Do not clean the leather with house hold polishes or cleaning products. The leather may look clean after use, but the life of the leather will be significantly reduced and may start to show signs of wear much quicker.

Fabric upholstery and carpets can be vacuumed and brushed with a soft brush to remove any dirt, mud or dust before cleaning with an interior upholstery cleaner to remove any staining or difficult to remove markings.

Steering wheel and trim features should be cleaned with a mildly damp cloth, moistened with undiluted upholstery cleaner. It is recommended to do a second wipe and clean of the steering wheel and trim features, with a clean soft cloth and luke-warm water, to remove any contaminants broken down by the upholstery cleaner. This should be followed by a wipe with a clean drying towel or soft micro fiber cloth to dry.

Seat Belt Care



CAUTION: The seat belt webbing should be left to dry naturally, while fully extended.



CAUTION: Do not clean the seat belt webbing with any household cleaning products, bleach, dye or solvents as this will cause the webbing material to weaken over time.

Make sure to fully extend the belts to clean all the webbing, use warm water and non-detergent soap to clean. Allow the belt to dry naturally while fully extended.



NOTE: Do not allow the belt to retract before fully dry and do not dry with heat, allow to naturally dry.

Regularly check the seat belt webbing and restraints to make sure they are all in working order, this includes the latches and buckles.



NOTE: Any seat belt worn during a serious collision must be replaced by a INEOS approved Service center.

MAINTENANCE AND TECHNICAL INFORMATION



WARNING: Any seat belt, buckle or latch not working correctly should be reported to the nearest INEOS approved service center, Do not drive with the seat of the seat belt in question occupied.

Radio and Screens



WARNING: Do not use abrasives, alcoholic solvents or chemical solvents to clean them.

Use a dry clean soft cloth to clean the radio and screens in the vehicle. Only use approved cleaning products, such as, screen cleaning sprays after carefully reading the manufacturers instructions label. Spray the cloth directly and not the screens.



NOTE: It is advised to press gently when wiping buttons and screens, as too much pressure may damage or scratch them.

HOSING THE INTERIOR



WARNING: Do not try to clean the interior while the vehicle is in motion.



WARNING: Remove the fire extinguisher (if applicable) from the vehicle before hosing down the interior. It is critical to do this to avoid damaging the fire extinguisher,

potentially leading to a malfunction when the device is used. If the fire extinguisher is exposed to water, consult your INEOS approved partner.



CAUTION: Park the vehicle on level ground before hosing the interior. Failure to do this, may result in water not travelling to the drainage plug holes.



CAUTION: Remove the tool kit from the vehicle before hosing down the interior.



WARNING: Do not go wading if the drainage plugs are not installed. The vehicle may flood with water.



WARNING: Do not allow children to hose down the interior of the vehicle without close supervision.



CAUTION: Do not hose anything, other than the flooring of the vehicle.



CAUTION: Do not use a high pressure cleaner to clean or hose out the interior



CAUTION: Do not allow water to splash the sockets and connectors above the middle tunnel of the vehicle. For example, the USB connectors have a protective lid, but they are not spring loaded. They are not water tight and if not closed, water can enter the connectors and electrical components. This will result in damage to the

MAINTENANCE AND TECHNICAL INFORMATION

connector and potentially leading to further malfunctions within the vehicle.



CAUTION: If the seats or seating mechanisms come into contact with water, then they should be dried immediately. Failure to do this can result in damage and corrosion.



CAUTION: Remove the tool kit from the interior of the vehicle before hosing down. Failure to remove the tool kit before hosing will result in damage to the tools within the kit.



CAUTION: Remove flooring mats (if applicable) before hosing down the floor for maximum drainage of water to the drainage plugs.



CAUTION: The Expanded Polypropylene foam (EPP) blocks, must be removed from the rear and front passenger foot-wells before hosing down the interior. Water can be trapped under the EPP foam blocks, if they are not removed before hosing down and drying the interior.



CAUTION: Remove the trim panel located just inside the rear loadspace entrance. This will give access to the rear drain plug inside the loading area.



CAUTION: Make sure the drainage plugs have been pulled out before hosing the flooring area of the vehicle for drainage.



CAUTION: The drainage plugs are not permanently attached or chained to the vehicle, take care to not misplace the plugs when hosing the flooring.



CAUTION: Do not use excess water to clean the interior, the cleaning and hosing out of the vehicle needs to be done carefully. For example, do not pour buckets of water into the interior as this can flood areas that can not be exposed to water.



CAUTION: Do not splash any electrical wires or connectors. If any electrical wires or connectors are exposed to moisture, they might corrode and break or result in a system failure.



CAUTION: Do not hose down or splash the air vent openings in the middle tunnel, they cannot be closed. Any water entering the air vents will result in damage to the heating, ventilation and air conditioning (HVAC) system within the vehicle.



CAUTION: Do not point the hose or direct the water into any gaps, openings or holes, where you cannot observe what the water might come into contact with.

MAINTENANCE AND TECHNICAL INFORMATION



CAUTION: Drainage openings in the interior trim are to allow water to drain, they must not be used for any other purpose.



CAUTION: Do not remove or tamper with the plastic trims located inside the door shuts, if the trims are removed you may risk voiding the corrosion warranty.

The floor area, such as, the foot-wells can be hosed out with a low pressure hose to remove any dirt or salts, that may have been trodden into the vehicle.

The maximum water flow rate when hosing down the vehicle interior, should be 5 l/min with a ½ inch water hose.

It is safe to hose down with a low pressure hose, the following areas:

- > Accelerator pedal rubber.
- > Brake pedal rubber.
- > Front and rear foot-wells.
- > Loadspace.
- > Removable foot-well trims.

This is not an exhaustive list but some examples of key areas that should not be hosed down under any circumstances due to the risk of malfunction:

- > Any electrical switches and plugs of the interior.
- > Wiring and electrical connectors (especially underneath both front seats).
- > Electrical components positioned under the rear seats.
- > Seat belt buckles, latches and tongues.
- > Airbags.
- > Gear Selector.
- > Steering Wheel.
- > Overhead Control Panel.
- > Front and rear seats.
- > Front seat rails and sliders.
- > Inner door trim.
- > Roof lining.
- > Centre Console.
- > Handbrake.



NOTE: Do not remove the water splash guard around the base of the rear seats, this is designed to protect the electrical components from water and moisture damage, which can lead to malfunction. This also applies to the

MAINTENANCE AND TECHNICAL INFORMATION

water splash guard in the loading area of the vehicle directly behind the rear seats. The water splash guards are installed to protect electrical components or connectors that might fail or malfunction, if they come into contact with moisture. Replace immediately if the water splash guards are damaged by consulting your nearest INEOS partner.



WARNING: Accessories, such as, the Loadspace Drawer must not be hosed down. Accessories are not corrosion resistant.

Only the flooring area should be hosed down, accessories should not be exposed to water or should be removed before hosing down of the interior.

Remove Interior Mats (OPTIONAL)



WARNING: Remove interior mats before hosing or washing the interior foot-wells.



WARNING: If the interior mats are splashed or accidentally hosed down then they should be dried immediately.



CAUTION: The Expanded Polypropylene foam (EPP) blocks, must be removed from the rear and front passenger foot-wells before hosing down the interior. Water can be trapped under the EPP foam blocks, if they

are not removed before hosing down and drying the interior.

Only hose down the interior, if the interior mats are removable, the front and rear passenger EPP foam blocks are removed and the drainage plugs are accessible. Please contact your INEOS approved partner for more information.



NOTE: When hosing out the flooring area of the vehicle the floor mats must be removed first. If there is non-removable mats or the floor is carpeted, then hosing down of the interior floor is not applicable.

Interior Drainage Plugs



WARNING: Drainage plugs must be removed before hosing down of the interior flooring.



WARNING: Do not leave any water in the vehicle after hosing down the interior flooring. After wipe out and drying, some water might still appear during or/and after driving, this is normal and should be dried as soon as possible.



WARNING: Make sure the drainage plugs are re-installed correctly before driving the vehicle after hosing has been completed.

MAINTENANCE AND TECHNICAL INFORMATION

There are drainage plugs located in each of the four foot-wells in the vehicle, these plugs must be pulled out and removed and it is advised only one foot-well at a time is hosed out, this is to ensure the dirty hose water can sufficiently exit the vehicle.



NOTE: Be wary of the location in which the vehicle interior is hosed out. Dirty water exiting through the interior drain plugs is directed underneath the vehicle

Safe Hosing Levels



WARNING: Only hose down the flooring area of the vehicle.



WARNING: Hose down one foot-well at a time to allow the dirty water to drain.



WARNING: Do not hose or splash any seating or seating mechanisms.



WARNING: Immediately dry the seats and seating mechanisms if they come into contact with any water or moisture.



WARNING: Do not use anything other than a hose pipe to hose down the interior, jet washes and other powered methods of cleaning are not suitable.



WARNING: Immediately dry electronics and connectors if anything is accidentally splashed and check for tell-tale warning lamps.



WARNING: Always keep a firm grip of the hose pipe and never leave unattended in the vehicle at any time.

When hosing the interior of the vehicle, it is essential that only the flooring is hosed, it is recommended that any large clumps of mud or dirt should be removed before hosing and anything that might block the drainage holes should also be removed. Start by gently hosing down one foot-well at a time and allow the dirty water to drain, once the water is draining well, continue to hose the vehicle floor. Keep the hose pointing down guiding the water towards the drainage holes.

It is important to avoid water coming into contact with the seating, seating mechanisms and any electronic wiring or connectors in and around the vehicle.



WARNING: There is an airbag connector located underneath both the front passenger and the front driver seat. The airbag connector should never come into contact with water or moisture, failure to keep this connector away from water could lead to the airbag system malfunctioning or failing. The tell-tale warning lamp might illuminate, but not always, if the airbag connector has come into contact with water. If you accidentally hose, splash or expose the connector to water you should immediately contact your INEOS approved partner for further advice and information.

MAINTENANCE AND TECHNICAL INFORMATION

The vehicle battery and electrical components are stored under the rear bench seat, they are protected with a cover around the immediate safe hosing area but care should be taken. Be sure to only hose around the flooring area of the rear foot-wells to avoid any water splashing that might enter a small gap between the battery cover and the rear bench seat.

 **WARNING:** Do not hose underneath the rear bench seat, as water will drain through the access holes in the top of the battery cover, causing damage to the battery, fuses and other electronic components. If water is splashed onto the seats, dry immediately, if the water enters the battery and fuse compartments, do not attempt to touch the components and seek further advice from an INEOS approved partner.

Hosing the Loadspace

 **WARNING:** Remove the front and rear foot-well mats (if applicable) and unplug all drainage plugs when hosing down the loadspace of the vehicle.

 **WARNING:** Do not hose down the loadspace of the vehicle if the Carpet Flooring option is selected or there are non-removable mats in the front, middle or rear of the vehicle.

 **WARNING:** Remove all items and luggage from the vehicle loadspace and foot-wells before hosing out is

started. This includes accessories and optional parts, such as, Cargo Barrier, Loadspace Divider and the Cargo Management System.



WARNING: Do not stand in the loadspace of the vehicle when hosing down, as the floor can become very slippery. If this is ignored there is a high risk of injury or death.

The rear loadspace of the vehicle can be hosed out to remove any dirt or contaminants around the loadspace flooring. It is strongly recommended that the flooring is swept free of any large clumps of dirt or stones and rocks, that might block the drainage hole. When hosing the rear loadspace, it is essential that the hose is directing the water towards the drainage hole, while avoiding any splashing of water onto the back of the seats or above the flooring area of the vehicle.



NOTE: The splash guard at the base of the seat back should not be removed to hose down the loadspace. Make sure the splash guard is in place to protect the seats from splashing and to make sure the water is guided away from the electrical components located underneath the rear bench seat.



WARNING: The lower rear seat cushion must remain in a horizontal seating position during the hose down procedure, the backrest must be in a vertical position. This will help stop water reaching the electrical components and connectors, which are located underneath the rear bench seat.

MAINTENANCE AND TECHNICAL INFORMATION

Any excess water will be directed down the sides of the rear seats to the drainage holes within the rear foot-wells to help with drainage.

Dirty water should be guided to the drainage hole at the rear of the vehicle to help avoid puddling of water in the vehicle, this will need to be done for the interior foot-wells to remove any excess water that may have drained down the drainage channels beside the rear seats.

Loadspace Drainage Plug



WARNING: Wading or off-roading without the plugs in place could result in flooding the interior and damage to the vehicle and/or its components. This may result in a crash that may lead to injury or death.



WARNING: Do not go wading in the vehicle if the drainage plug is not re-installed.



CAUTION: Remove the tailgate scuff plate at the rear of the vehicle, this will give access to the drainage plug in the loadspace. If the drainage plug in the rear loadspace is not removed when hosing out the vehicle, damage can be caused.



CAUTION: Re-install drainage plugs before driving the vehicle.

Remove the tailgate scuff plate before hosing down the loadspace. Remove the drainage plug which is located underneath and clear the gully of dirt. This will ensure water can flow freely down the gully and out of the drainage plug.



NOTE: Make sure the scuff plate is re-installed correctly after re-installing the drainage plug.

Drying After Hosing



WARNING: Do not go wading or off-roading if the drainage plugs have been lost or not re-installed.



WARNING: Always allow the vehicle time to dry out sufficiently before driving.



WARNING: Do not leave the vehicle unattended when the doors and windows are open.



WARNING: Do not climb into the vehicle until the floor is fully dry as there is a risk of slipping and falling, which can lead to serious injury or death.

It is important to allow the vehicle to dry out completely, before driving or closing the doors and windows. Any puddling of water, should be directed to the nearest drainage hole, followed by the wiping of any areas of the floor that is still wet, with a clean drying towel.

MAINTENANCE AND TECHNICAL INFORMATION



NOTE: INEOS recommends that the windows and doors of the vehicle are left open to help air enter and leave the vehicle, removing any remaining moisture after manual drying is completed.



WARNING: Do not drive the vehicle, if the tyre pressure is not correct. Driving with incorrectly inflated tyres can lead to uneven wear to the tyres, significantly reducing the life of the tyre and seriously affect the handling characteristics of the vehicle.



NOTE: Tyre pressures must be checked regularly and adjusted when necessary. It is however, recommended to check for signs of wear or damage at the same time.

WHEELS AND TYRES

General Information



WARNING: Use the correct size of tyre for the vehicle, using the wrong size tyre could damage the vehicle and significantly reduce the vehicle safety.



WARNING: If for any reason the tyre size is changed, immediately seek advice from an INEOS approved partner. It is important to not drive the vehicle before consulting with your INEOS approved partner as the speedometer may not display the correct speed or the stability of the vehicle might be significantly different to factory fitted tyre.



WARNING: Do not drive the vehicle if the tyres are damaged, such as, cuts or bulges. Driving with a damaged tyre can result in a serious crash. If there is damage to any tyre on the vehicle, including the spare wheel, consult with your INEOS approved partner.

The wheels and tyres on the vehicle are not only designed for use on roads, but also to be used off-road and wading. It is important that the wheels and tyres on the vehicle, including the spare wheel and tyre are replaced with parts that meet the original equipment specifications from factory. If the wheels and tyres are changed for parts that do not meet the required specifications, then this has a significant impact on the performance of the vehicle handling and life of the suspension system components.

Tyre Care



WARNING: Do not drive the vehicle, if the tyres are showing signs of damage or wear. Consult with your INEOS approved partner immediately.



WARNING: Do not drive the vehicle with a low inflated or flat tyre. This can cause further damage to the vehicle, or even a crash causing injury or death.

MAINTENANCE AND TECHNICAL INFORMATION

It is important to frequently check the tyres on the vehicle, including the spare wheel. Checks should be carried out on the vehicle by the driver at least once a week if used on normal roads

and before and after long journeys, or before and after every off-road use. Always check the full tyre for signs of damage.

	TYRE AREA	TYRE CHECK
1	Tyre pressure	The correct tyre pressure for the vehicle, can be found inside the fuel flap. Check the tyre pressure when the tyres are cold, before driving the vehicle.
2	Outer tyre wall	Check the outer wall for signs of damage such as cracks, bulges, cuts or lumps.
3	Inner tyre wall	Check the inner wall for signs of damage such as cracks, bulges, cuts or lumps.
4	Tyre tread	Check the tyre tread for any foreign objects, such as, screws, nails, stones, glass or any other object that might damage or puncture the tyre.
5	Tyre tread depth	Check the tyre tread depth, ensuring there is a minimum of 1.6mm tread depth. Use a tread depth measuring tool or check using the tyre wear indicators located within the tyre tread pattern.
6	Valve caps	Make sure all the valve caps are on the tyre valves. The valve cap stops any debris or dust getting into the valve, preserving the life of the valve to stop any air leakage.



WARNING: Immediately consult with your INEOS approved partner, if any of the above is found to be wrong with any tyre on the vehicle, including the spare. Consult with your INEOS approved partner if any other damage or fault is evident.

Spare Wheel and Stowage



CAUTION: Do not put a punctured or damaged wheel back onto the spare wheel stowage. Any damaged or punctured wheels and tyres should be placed into the loadspace of the vehicle.

MAINTENANCE AND TECHNICAL INFORMATION



WARNING: The spare wheel is heavy and should only be taken off the stowage and wheel carrier with the help of another person(s).

The Vehicle comes with a spare wheel in the event of a wheel and tyre being damaged.

The spare wheel is located at the rear of the vehicle and is secured with three wheel nuts and a mounting ring. To get to the spare wheel, you must first remove the Spare Wheel Cover or optional Spare Wheel Lockable Storage Box. (If applicable, unlock the Spare Wheel Lockable Storage Box and remove carefully). Next, undo the three wheel nuts holding the spare wheel in place. The mounting ring should slide off the threaded studs, and the spare wheel should then be removed from the vehicle.

Changing a Road Wheel



WARNING: Seek assistance from an INEOS approved partner, if you are in any doubt of carrying out a wheel change procedure. Changing a wheel can be dangerous if not done correctly, risking serious damage to the vehicle and injury or death to the vehicle occupants and others around you.



WARNING: When changing a wheel at the roadside, always make sure the location is a safe place to carry out the procedure. The hazard warning lamps must be switched on, warning vest worn and warning triangles situated to warn other drivers of your presence.



WARNING: Ensure heavy luggage and passengers are out of the vehicle before raising the vehicle for a wheel change. If towing a trailer secure and disconnect it.



WARNING: Make sure the vehicle is on stable and level ground before lifting the vehicle, to change a wheel.



WARNING: Do not use the bottle jack to support the vehicle at anytime, other than to change a wheel. No persons should be under the vehicle, for any reason, when the vehicle is lifted on the bottle jack.



WARNING: It is recommended when jacking the vehicle up, that the other wheels are chocked to help ensure there is no unexpected vehicle movement.

To change a road wheel, follow the following procedure:

1. Before raising the vehicle off the ground, loosen each of the six wheel bolts one full rotation.
2. Raise the vehicle until the tyre of the wheel being changed is not touching the ground.
3. Remove the six wheel nuts from the wheel completely, keep one hand on the wheel when removing last wheel nut to ensure it does not fall off.
4. Remove the wheel from the vehicle carefully to prevent damage to the wheel or the vehicle.

MAINTENANCE AND TECHNICAL INFORMATION

5. Place the wheel in a safe location away from you and the vehicle. Do not place face down as this can scratch and damage the wheel.
6. It is recommended that the immediate area of contact between the wheel and the vehicle hub is cleared of any dirt or surface corrosion.
7. Place the spare wheel onto the hub, in place of the removed wheel. Be sure to hold the wheel on with one hand to ensure it does not fall off.
8. Install the six wheel nuts back onto the threaded studs, they should be tightened enough to keep the wheel in place against the wheel hub.
9. Clear the vehicle of any obstructions, such as, tooling or the removed wheel.
10. Lower the vehicle back down slowly and safely, until the wheels are all securely on the ground and remove the bottle jack.
11. Finally, torque each of the six bolts up to 160 Nm, this must be done in the sequence shown in the image

below. This ensures the wheel is securely fixed into place on the vehicle hub.

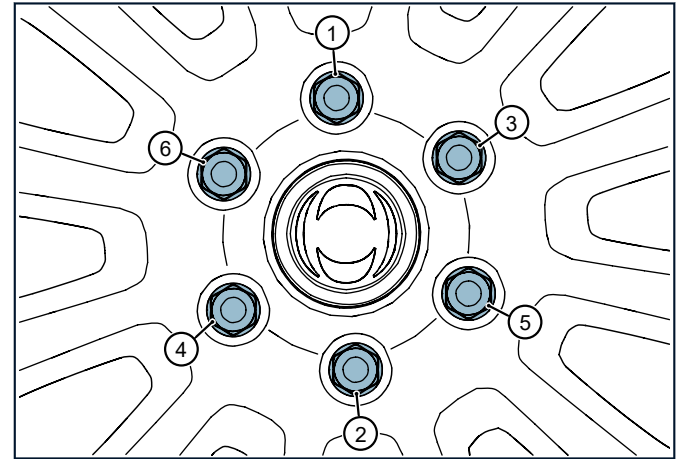

NOTE: It is recommended that the wheel nuts are checked after a short journey to ensure they are secure.

Snow Chains



CAUTION: It is not recommended to use snow chains on roads that are not heavily covered in snow. Snow chains can damage the road surface and the vehicle.

MAINTENANCE AND TECHNICAL INFORMATION



CAUTION: Ensure compliance with local laws on the use of snow chains.

Snow chains available for the vehicle:

- > A 82 S AUSTRO-S
- > XMR 82 V BRENTA-C 4x4

It is recommended that snow chains are used on both axles, all four wheels. Alternatively, install snow chains to the rear wheels

only. Snow chains must only be used on roads that are heavily covered in snow. Driving the vehicle where there is minimal to no snow can result in damage to the vehicle.

Technical Specifications

Recommended tyre brand and size:

MODEL	WHEEL DIAMETER	SERVICE TYPE	TYRE WIDTH	SIDEWALL HEIGHT	SPEED RATING	MAX LOAD
BF Goodrich All Terrain T/A KO2	17"	L T - Light truck carrying heavy load.	265	70	S	1450kg
BF Goodrich All Terrain T/A KO2	18"	L T - Light truck carrying heavy load.	255	70	S	1285kg
Bridgestone Dueler AT001	17"	PSR - Passenger Tyres	265	70	S	1250kg(2756lb)
Bridgestone Dueler AT001	18"	PSR - Passenger Tyres	255	70	S	1250kg(2756lb)

There is no special recommendation for snow or off-road, as the recommended tyres are suitable for off-road and all seasons.

The recommended tyre pressures dependent on the vehicle load are as follows:

MAINTENANCE AND TECHNICAL INFORMATION

TYRE DIMENSION	FRONT, REAR, SPARE	bar	kPa	PSI	PASSENGERS AND LOAD
LT 265/70/R17 S	FRONT	2,5	250	36	Max. 3 people
	REAR	2,5	250	36	
	SPARE	3,4	340	49	
	FRONT	3,0	300	43.5	5 people plus luggage
	REAR	3,4	340	49	
	SPARE	3,4	340	49	
LT 255/70/R18 S	FRONT	2,5	250	36	Max. 3 people
	REAR	2,5	250	36	
	SPARE	3,4	340	49	
	FRONT	3,0	300	43.5	5 people plus luggage
	REAR	3,4	340	49	
	SPARE	3,4	340	49	

Tyre Pressure Monitoring System (TPMS)



WARNING: The TPMS is not a substitute for correct manual tyre maintenance, it is the driver's responsibility

to maintain correct tyre pressures with a tyre pressure gauge. INEOS recommends inspection of each tyre, checking the tyre pressures, every two weeks or before and after off-road driving or wading.

MAINTENANCE AND TECHNICAL INFORMATION



WARNING: The tyres may overheat and potentially lead to tyre failure if substantially under-inflated. Over inflation and under-inflation also reduces fuel efficiency and tyre tread life. This can lead to tyre failure, which may then lead to loss of control, injury and even death.



NOTE: Tyre sealants can cause damage to the tyre pressure monitoring system and should only be used in roadside emergencies.

The tyre pressure monitoring system (TPMS) is installed as a safety feature. The TPMS is designed to give individual tyre pressure and temperature reading information on demand once the wheels are rotating. The system will give a warning if the pressure is below the minimum pressure.

The TPMS system is autonomous to identify when the spare wheel is installed the system will automatically detect the new position.

The TPMS system will automatically self-test after power-on, the tyre pressure warning symbol will be illuminated. If no system errors are detected it will be extinguished, otherwise it shall remain illuminated until error is resolved. If there are any errors or malfunctions, then it is advised to consult with your INEOS approved partner.

Tyre Pressure Display

The tyre pressure display provides information on all four rotating tyres, the information shown is the actual temperature and pressure of the tyres including the tyre position on the vehicle.

Warning Information

The following table, displays the warning information that may be visible or heard, when triggered.

FAULT	WARNING	TELL-TALE	ACOUSTIC
Tyre Pressure Leakage	Stop the vehicle, Fast leakage detected	YES	YES
Tyre Pressure Low	Tyre pressure is too low, please check	YES	YES
Tyre Pressure High	Tyre pressure is too high, please check	YES	YES
Tyre Temperature FL high (Front Left)	The temperature is too high, please check	YES	YES

MAINTENANCE AND TECHNICAL INFORMATION

FAULT	WARNING	TELL-TALE	ACOUSTIC
System Malfunction	Contact an INEOS approved partner to check TPMS	YES	NO
Tyre Pressure Sensor Lost	Contact an INEOS approved partner to check sensor	YES	NO
Sensor Battery Low	Contact an INEOS approved partner to check sensor battery	YES	NO

CUSTOMER INFORMATION

Radio Frequency Identification (RFID)

INEOS use RFID technology in the vehicle, for example, tyre pressure monitoring and radio remote controls, such as, the key fob to unlock and lock the vehicle.

INEOS vehicles with RFID do not use or record personal information with any other INEOS system containing personal information.

Registered Trademarks

Apple Inc.

Apple CarPlay™ is a trademark of Apple Inc .

App Store® is a registered trademark of Apple Inc .

iPhone® , iPod® and Siri® are registered trademarks of Apple Inc .

Bluetooth SIG, Inc .

Bluetooth® is a registered trademark of Bluetooth SIG, Inc .

Google Inc .

Android™ and Google Play™ Store are trademarks of Google Inc .

Verband der Automobilindustrie e.V.

AdBlue® is a registered trademark of the VDA .

WARRANTY INFORMATION

CUSTOMER STATEMENTS	217
INTRODUCTION	217
WARRANTY COVERAGE PERIODS	217
THINGS YOU SHOULD KNOW ABOUT INEOS WARRANTY	219
GENERAL WARRANTY CONDITIONS	223
GENERAL MAINTENANCE	223
EXTREME USE SERVICING SUGGESTION	223

WARRANTY INFORMATION

CUSTOMER STATEMENTS

Our goods and services come with guarantees that cannot be excluded under the Australian Consumer Law. For major failures with the service, you are entitled:

- to cancel your service contract with us; and
- to a refund for the unused portion, or to compensation for its reduced value.

You are also entitled to choose a refund or replacement for major failures with goods. If a failure with the goods or a service does not amount to a major failure, you are entitled to have the failure rectified in a reasonable time. If this is not done, you are entitled to a refund for the goods and to cancel the contract for the service and obtain a refund of any unused portion. You are also entitled to be compensated for any other reasonably foreseeable loss or damage from a failure in the goods or service.

Markets excluding Australia:

The warranties contained herein are in addition to and do not detract from any rights you may have under your local consumer legislation.

INTRODUCTION

INEOS Automotive Limited ("INEOS") issues a warranty for each new INEOS vehicle sold, registered and operated where authorised INEOS dealers or agents are located by a customer. Within the period of time and mileage specified in the table below,

an INEOS Automotive Approved Workshop will repair (or, at INEOS' option) replace free of charge those parts or components which are covered by the section's description and which prove defective in materials or workmanship. Parts which are excluded from warranty are listed under "what is not covered". The method of repairing or replacing is to be determined by the INEOS Automotive Approved Workshop.

All warranties provided by INEOS are subject to the terms and conditions and exclusions, referred to below.

WARRANTY COVERAGE PERIODS

The warranties in this document include the following:

New Vehicle Warranty

The INEOS New Vehicle Warranty, as defined in the 'Warranty Coverage Period Table', covers all parts and components of each new INEOS vehicle supplied by INEOS, which prove defective in materials or workmanship.

Paint Warranty

The Paint Warranty, as defined in the 'Warranty Coverage Period Table', covers painted body parts (excluding the underbody) which suffer from paint defects as a result of defective materials or workmanship.

WARRANTY INFORMATION

Anti Perforation Warranty

The Anti Perforation Warranty covers body sheet metal panels and chassis frame which suffer from inside-to-outside perforation from corrosion, as a result of defective materials or workmanship. The period for the Anti Perforation Warranty is 12 years from warranty start date.

This warranty requires that the vehicle is inspected, and repaired, if necessary, by an authorised INEOS Automotive Approved Workshop. Inspection and repair is required annually after the warranty start date.

Genuine Parts and Accessories Warranty

INEOS Automotive Limited issues a warranty, as defined in the 'Warranty Coverage Period Table', for all INEOS genuine parts and accessories supplied for installation on an INEOS vehicle to be free from defects in materials or manufacturers workmanship.

Warranty Coverage Period Table

The following warranty periods apply from the date of first retail registration:

REGION	MECHANICAL	PAINTWORK	ANTI-PERFORATION	PARTS	ACCESSORIES	EMISSION
UK and Europe	5 Years unlimited mileage	3 Years unlimited mileage	12 Years	2 Years unlimited mileage	3 Years unlimited mileage	5 Years 100,000 miles (160,000 km)
Australia and New Zealand	5 Years unlimited mileage	5 Years unlimited mileage	12 Years	2 Years unlimited mileage	5 Years unlimited mileage	5 Years 100,000 miles (160,000 km)
Africa	5 Years 60,000 miles (100,000 km)	3 Years 60,000 miles (100,000 km)	12 Years	2 Years unlimited mileage	3 Years unlimited mileage	5 Years 100,000 miles (160,000 km)
Middle East and Asia	5 Years unlimited mileage	3 Years unlimited mileage	12 Years	2 Years unlimited mileage	3 Years unlimited mileage	5 Years 100,000 miles (160,000 km)

WARRANTY INFORMATION

All warranties terminate at the end of the periods set out above.

Emission Component Warranty

The Emission Component Warranty as defined in the 'Warranty Coverage Period Table', warrants parts installed on your INEOS vehicle which have the sole or primary purpose of reducing your vehicles emissions to be free from defects in materials or manufacturers workmanship.

THINGS YOU SHOULD KNOW ABOUT INEOS WARRANTY

Tyres

Tyres, even when originally installed on new INEOS vehicles, are warranted by the tyre manufacturer. An INEOS Automotive Limited Approved Workshop, will assist you in making a warranty claim for tyres, if necessary. INEOS is not liable for repair or replacement of the tyres or any costs relating to such repair or replacement.

Pre-Delivery Inspection

To make sure you will be completely satisfied with your new Grenadier from the very start, it has been inspected and prepared before delivery, according to INEOS's New Vehicle Pre-Delivery Inspection Procedure.

Periodic Maintenance Service

Your vehicle must be serviced in accordance with INEOS' periodic servicing schedule, be performed in accordance with INEOS

recommended requirements, and carried out by your INEOS Automotive Approved Workshop.

This is to ensure good engine and emission control system performance and good mechanical condition of your new vehicle. Scan the QR code inside the 'Service and Maintenance' section, for your vehicle's servicing requirements.

Failure to adhere to this may result in your warranty claim being rejected and INEOS may ask to see evidence the vehicle has been properly serviced.

If you elect to maintain your vehicle yourself or use a non-INEOS approved workshop to perform any scheduled maintenance or repair activities, INEOS recommends you keep accurate records relating to the products, parts, fluids used, odometer reading and date of maintenance to support any future claims under the provision of the INEOS New Vehicle Warranty. We also recommend all maintenance and repairs are only performed by suitably qualified persons as errors in maintenance may lead to damage to, or operational issues with, your vehicle.

Servicing need is based on a time or mileage/Km based schedule. You should arrange an appointment with your INEOS Automotive Approved Workshop when your vehicle reaches either the appropriate mileage or time interval. For example, for a 12,000 mile (20,000 km) /12-month maintenance schedule, the service will be due when you've driven 12,000 miles (20,000 Km) or the vehicle has been registered for one year, whichever occurs first. Vehicles should be serviced within 1,000 miles (1,600 Km) or one month of the due time or distance.

WARRANTY INFORMATION

INEOS Automotive Approved Workshop

It is recommended that servicing be performed by an INEOS Automotive Approved Workshop to ensure that servicing and maintenance is carried out to a required standard. They will have a direct interest in your satisfaction as an INEOS customer, familiar with your vehicle and are updated regularly on each INEOS model. They are equipped and trained to provide optimum service to your INEOS vehicle.

Genuine INEOS Parts and Accessories

Genuine INEOS parts and accessories are approved by INEOS for use on INEOS vehicles. Only genuine INEOS parts and accessories are covered by INEOS's Genuine Parts and Accessories Warranty.

Damage caused to your vehicle as a result of fitting Non-genuine Parts and Accessories is not covered by this warranty.

Warranty Service in Other Countries

INEOS Warranties are valid in regions in which the vehicle is originally sold. However, if a warranty repair is required in another region, you can contact your local INEOS workshop who will be happy to repair your vehicle under the terms of your warranty.

For Warranty Coverage see the 'Warranty Coverage Period Table' above.

Design or Specification Change

INEOS has the right at any time, to make changes to the design or specifications of any INEOS vehicle, without notice and without

obligation to update or make changes on vehicles that sold before the update or change was implemented.

What Is Not Covered

1. Tyres
2. Any non-genuine parts, accessories or other equipment which is not approved by INEOS for use on the vehicle.
3. Any consumables, parts and/or labour cost incurred as a result of, or in connection with, required or recommended maintenance service such as, but not restricted to, adjustments (including, but not limited to, wheel balancing and alignment, engine tune-up, headlight aiming), light bulbs, exhaust system and particulate filters (unless proven to be materially defective), spark plugs, drive belts, brake discs, brake pads, other filters, upholstery and trim, (unless materially defective) wiper blades, fluids or lubricants, (unless replaced as part of a warranty repair)

WARRANTY INFORMATION

4. Damage, failures or corrosion resulting from:
 - > Misuse, accident, theft, arson or intentional damage.
 - > Industrial fall-out, acid or alkali contamination, stone chipping, chemical fall-out, tree sap, bird droppings, salt, hail, windstorm, lightning or other environmental conditions.
 - > Failure to follow the relevant guidelines given in the Owner's Manual and under the caption *what you must do* in this section.
 - > Use which is not in accordance with (or failure to follow the relevant guidelines given in) this Owner's Manual
 - > Continuing to use the vehicle if a fault has become apparent.
 - > Failure or unreasonable delay in having the vehicle repaired at the earliest opportunity after a defect has become apparent.
 - > Failure to follow proper maintenance services as defined by INEOS.
 - > Modification or alteration of the vehicle or any parts fitted to it or improper repair.
 - > Repairs not performed by an authorised INEOS Automotive Approved Workshop.
 - > Use of non-genuine parts, accessories or other equipment which is not approved by INEOS for use on the vehicle; or
 - > Use of improper or contaminated fuel, fluids, or lubricants.
5. Normal deterioration of trim, paint, or other cosmetic items (normal wear and tear).
6. Any vehicle on which the odometer has been altered or replaced so that the reading does not correspond with the actual mileage of the vehicle or on which the Vehicle Identification Number and/or Engine Number have been altered or removed.
7. Incidental or consequential damages such as loss of use of the vehicle, inconvenience, or commercial loss.
8. Any vehicle that has previously been involved in an incident that in INEOS' sole discretion rendered the vehicle as a total loss or which an insurer has previously decided was a total loss, because it was lost, stolen, destroyed or damaged beyond economic repair (whether or not this was your fault or the fault of the registered owner at the time of the incident).
9. Damage or other wear arising from racing, track days, off-road trials, other competition, or events.
10. Investigative/diagnostic work in connection with a fault which is not covered by this warranty.
11. Paintwork, bumpers, grilles and other bodywork (except where this is covered under the Paint Warranty).

WARRANTY INFORMATION

12. Paintwork which is covered by any stickers or vinyl wraps.
 13. Stripping or dismantling of the vehicle except as part of a valid warranty claim.
 14. Labour time associated with the removal of any aftermarket accessories fitted to the vehicle in cases where access is restricted by the accessory and removal is required to replace a defective component in completing a warranty repair.
4. Retain:
 - > All maintenance service records.
 - > All documents and invoices relating to parts or accessory installations.
 5. As for the Paint Warranty and the Anti Perforation Warranty, you must:
 - > Carefully read vehicle care and maintenance instructions given in the Owner's Manual.
 - > Arrange for an INEOS Automotive Approved Workshop to carry out the annual paint inspection and documented on the Maintenance Record.
 - > Wash the vehicle regularly.
 - > Remove salt, sand, ice melting agents, road and oil tar, tree sap, bird droppings and other potentially harmful materials immediately when they are found on the vehicle.
 - > Promptly repair any damage to the surface finish of the vehicle at your own expense.
 6. Maintain the vehicle in accordance with the "General Maintenance" section below.
 7. You must not make a false, dishonest, or misleading claim. This warranty will be invalidated if we believe you have made such a claim.

What We Will Do

All warrantable defects will be repaired by an INEOS Automotive Approved Workshop, at no charge to the customer for labour or parts within the limitations, set out in this Owner's Manual.

What You Must Do

1. Properly use, maintain and care for your vehicle, as outlined in this Manual.
2. Take the vehicle to an official INEOS Automotive approved workshop place of business during regular business hours, at your expense, in order to obtain warranty service.
3. Check for trim, paint, or other cosmetic defects at the time the new vehicle is delivered and report any issues to the INEOS dealer or agent who delivered your vehicle.

WARRANTY INFORMATION

GENERAL WARRANTY CONDITIONS

The following general conditions apply to this warranty:

1. This warranty does not affect your right to make a claim under any other warranty or insurance applicable to the vehicle but INEOS may reduce the amount of any claim made under this warranty by the amount recovered under any such alternative warranty or insurance.
2. You may not cancel this warranty and no refund will be made in the event that this warranty is invalidated or transferred.
3. If you sell the vehicle privately, this warranty will transfer to the new owner. The new owner should:
 - > Contact INEOS to ensure that ownership records are updated; and
 - > Check that the requirements of this warranty have been met.
4. Some or all of the benefits of this warranty may not be available to the new owner if:
 - > the vehicle has not been maintained in accordance with the requirements of this warranty document, or
 - > the vehicle has not been used in accordance with the conditions of this warranty.
5. From time to time it may be necessary to change the terms of this warranty to reflect changes in the law. We

may make such changes by giving you no less than 1 month's notice (either directly or via our partners or our website).

6. This warranty (and any related issues) is governed by English Law and subject to the jurisdiction of the English Courts.

GENERAL MAINTENANCE

During the normal day-to-day operation of the vehicle, general maintenance should be performed regularly as prescribed in this section. If you detect any unusual sounds, vibration or smell, be sure to check for the cause or have your INEOS Automotive Approved Workshop check it promptly. In addition, you should notify your INEOS Automotive Approved Workshop if you think that repairs are required.

When performing any checks or maintenance work closely observe the precautions outlined in this manual.

EXTREME USE SERVICING SUGGESTION

Clearly, we've built the Grenadier to operate in the toughest conditions, environments, and terrains possible, day in, day out. But as you'll understand, even the most rugged vehicles put through persistent extreme use may need a little extra looking after. So, if you fall into this camp, we suggest you have your Grenadier serviced every six months. That way you can be sure

WARRANTY INFORMATION

your Grenadier continues to give you the levels of performance you rely on.

INDEX

A

About This Manual	15
Access Ladder (OPTIONAL)	93
AdBlue (Diesel Engine Only)	96
AdBlue Filler Location	97
AdBlue Levels and Warnings	97
AdBlue Tank Capacity	186
Air Conditioning Button	166
Air Flow Zones	166
Airbag Deployment	48
Airbag Malfunction	48
Airbags	47
Ambient Lamps	68
Anti-lock Brake System (ABS)	110
Audio	151
Audio Options Menu	152
Audio Output Specification	163
Automatic Locking Retractor	57
Automatic Transmission	81
Auxiliary Battery (OPTIONAL)	188
Auxiliary Charge Points (OPTIONAL)	163
Auxiliary Switch Panel and Electrical Preparation	189

B

Backrest Angle Adjustment	36
---------------------------------	----

Battery	186
Battery Disposal	188
Battery Information	187
Battery Level Protection	188
Bluetooth Audio	156
Bluetooth Options	157
Body Maintenance	199
Bonnet Release	176
Bottle Jack	118
Brake Fluid	182
Brake Pad Wear Indication	182

C

Call Active	147
Capacities and Technical Information	168
Car Wash Function	84
Central Control Interface (CCI)	132
Centre Console Controls	23
Centre Differential Lock	89
Changing a Road Wheel	211
Changing the Battery	187
Checks Before Driving	20
Child Door Locks	57
Child Restraint System Detailed Information	52
Child Restraint System Seating	51

INDEX

Child Safety	50
Child Seat and Front Passenger Airbag	53
Child Seat Belt	52
Child Seat with Seat Belt Installation	56
Cleaning the Radio and Screens	201
Component Location	15
Connecting Android Auto	32, 150
Connecting Apple CarPlay	31, 150
Connecting Phone	144
Connecting Phone Device	31, 149
Cruise Control	105
Cruise Control Activation	106
Cruise Control Deactivation	107
Cruise Control Resuming Set Speed	107
Cruise Control Speed Adjustment	106
Customer Information	215

D

Dangerous Substances	175
Data Recording	18
Daytime Running Lamps	71
Dial a Call	147
Differential Lock Front and Rear	91
Differentials	88
Dimensions	171

Downhill Assist	110
Downhill Assist Activation	110
Downhill Assist Adjusting the Speed	111
Downhill Assist Deactivation	111
Driving Abroad	75
Driving Safety	18
Driving with a Roof Load	93
Drying After Hosing	208

E

Eco Start / Stop ESS	60
Eco Start / Stop Operation	61
Electrical Systems	186
Electronic Stability Control (ESC)	109
Emergency Stop Signal (ESS)	107
Emission Control	175
Engine Coolant	180
Engine Oil	176
Engine Oil Refill	179
Engine Oil Viscosity Grades	179
Engine Oils and Disposal Warnings	174
Engine Running-in	59
Environment Protection	174
ESC OFF Mode	109
Exterior Care	195

INDEX

Exterior Mirrors	64
Exterior Utility Belt (OPTIONAL)	92
External Lamps	69
Extreme Use Warranty	224

F

Fan Speed Settings	165
Fire Extinguisher (OPTIONAL)	117
First Aid Kit	117
First Row Reading Lamps	67
Folding Rear Seat	40
Follow Path	141
Front Data-In USB Ports	163
Front Towing Eyes	120
Fuel	184
Fuel Economy	185
Fuel Level and Remaining Range Warnings	95
Fuel Safety	185
Fuel System	172
Fuel Tank Capacity	186
Fuses	195

G

Gear Selection	83
Gear Selector Positions	82

Gear Shift Indicator	85
General Warranty Conditions	223
Glass and Mirror Care	197

H

Handbrake	81
Hazard Warning Lamps	26, 73
Head Restraint Adjustment	38
Head Restraints	36
Headlamp Care	198
Headlamp Range Adjustment	74
Headlight Unit	183
Heated Front Seat	165
High Beam	71
High Load Auxiliary Switch Panel and Electrical Preparation (OPTIONAL)	189
Highlight Cursor	134
Horn	25, 63
Hosing The Interior	204
Hosing the Loadspace	207

I

Ignition Position	60
Incoming Call	146
Indicators	72

INDEX

Infotainment Acoustic Settings	160	Interior Mirror	65
Infotainment Call Bar	148	Interior Utility Rails (OPTIONAL)	92
Infotainment Communication Settings	161	ISOFIX and I-Size Anchors	53
Infotainment DAB	154		
Infotainment Device Menu	148	<i>J</i>	
Infotainment Display Settings	158	Jacking Up the Vehicle	120
Infotainment FM/AM	154	Jump Start Procedure	124
Infotainment General Settings	158	Jump Starting	124
Infotainment Header	137		
Infotainment Home	138	<i>K</i>	
Infotainment Home Audio	139	Key and Remote Fob	21
Infotainment Home Favourites	140	Key Fob Battery Replacement	128
Infotainment Keyboard	136	Key Fob Buttons	127
Infotainment Keypad	146		
Infotainment Navigation Bar	135	<i>L</i>	
Infotainment Options Menu	134	LED Auxiliary High Beam Lights	73
Infotainment Pathfinder File Transfer Menu	162	Loadspace Drainage Plug	207
Infotainment Search	145	Loadspace Lamps	68
Infotainment Settings Menu	157	Lockable Front and Rear Differentials (OPTIONAL)	89
Infotainment Sub Menu	144	Low Beam	70
Infotainment Vehicle Functions Settings	159		
Interior Care	199	<i>M</i>	
Interior Drainage Plugs	205	Manual Mode and Shifting	85
Interior Lamps	67	Mass and Load	169
Interior Mats	204	Media and Infotainment	130

INDEX

O

Occupant Restraint System	41
Off-Road Driving	101
Off-Road Electrical	142
Off-road Mode	102
Off-Road Pathfinder Navigation Mode	141
Off-Road Statistics	142
Off-Road Temperature	140
Off-Roading Attitude	140
Opening Fuel Cap	95
Opening Fuel Flap	95
Owner Maintenance Checks	176

P

Paint Work Care	198
Park Distance Control	112
Parking Aid Systems	112
Parking Distance Control Malfunction	114
Parking Sensor Activation	113
Parking Sensor Deactivation	113
Parking Sensor Operation	114
Particulate Filters	97
Parts and Lubricants	172
Passenger Airbag Deactivation	53
Permanent 4x4	88

Phone	143
Polishing and Waxing	199
Pre-tensioner and Load Limiting	43
Puddle Lamps (OPTIONAL)	68

Q

QR Code	172
---------------	-----

R

Radio Frequency Identification (RFID)	215
Raised Air Intake (OPTIONAL)	104
Raised Air Intake Cyclone Pre-Cleaner (ACCESSORY)	104
Rear Fog Lamps	72
Rear Seat ISOFIX/i-Size	54
Rear Towing Eyes	120
Rear Window Wiper	79
Rear-View Camera (OPTIONAL)	115
Rear-View Camera Activation	115
Rear-View Camera Deactivation	116
Recirculation Button	166
Record Path	141
Recovery	120
Registered Trademarks	215
Restraint System	173

INDEX

Reverse Lamps	73
Road Wheel Care	198
Roadbook	142
Roadside Emergencies	117
Rolling or pushing the Vehicle	84
Roof Loading	93

S

Safari Windows (OPTIONAL)	66
Safe Hosing Levels	206
Seat Adjustment	35
Seat Belt care	201
Seat Belt Fastening	45
Seat Belt Reminder	45
Seat Belt Unfastening	46
Seating	34
Seating Driving Position	34
Service and Maintenance	171
Service History	172
Servicing and Maintenance Safety Precautions ...	174
Snow Chains	212
SOS Automatic Operation	117
SOS Emergency Call (eCall)	116
SOS Malfunction Warning	117
SOS Manual Operation	117

Spare Wheel and Stowage	210
Starting and Stopping the Engine	59
Starting the Engine	60
Steering Wheel Adjustment	21
Steering Wheel Controls	25, 63, 132
Switching Off the Engine	60

T

Technical Specifications	213
Tell-tale Lamps	29
Temperature Auto Settings	165
Tether Anchor Points	55
Tool Kit	118
Toot	25, 63
Towing	122
Towing a Trailer	125
Trailer Stability Assist	125
Transfer Case Selector Positions	87
Transporting the Vehicle	122
Tuner	152
Two-Speed Transfer Case	85
Tyre Care	209
Tyre Pressure Display	214
Tyre Pressure Monitoring System	214
Tyre Pressure Warning Information	215

INDEX

U

Under Bonnet Cleaning	198
Underride Protection (OPTIONAL)	199
Uphill Assist	111
Upholstery and Carpet Care	200
USB Audio Connection	155
USB Connectivity	163
USB Options	156

V

Vehicle Loading	91
Vent Adjustment	166
VIN Vehicle Identification and Engine Number	17
Volume and Mute	132
Volumes and Loadspace	170

W

Wading Mode	104
Warning Triangle	117
Warning Vest	118
Warnings, Cautions and Notes	15
Warranty	217
Warranty Coverage Periods	217
Warranty General Maintenance	223
Washer Fluid Level	177

Washing the Vehicle	197
Water Separator	181
Wheels and Tyres	208
Window Demist Front	166
Window Demist Rear	166
Windows	64
Windows and Mirrors	63
Windscreen Wiper	77
Wiper Blade Condition	182
Wiper Blade Replacement	183

INEOS

GRE^ADIER

